

A2508 XA/XAD CONNECTOR

2.50mm Pitch/Disconnectable Crimp style connectors

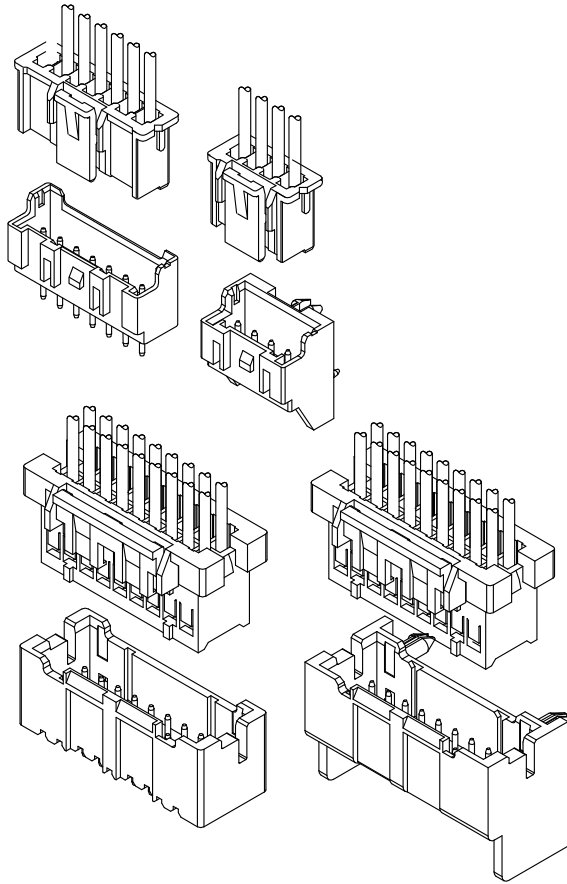

- Secure locking structure
- Low insertion force
- Suction area for picking up
- Improvement of engagement with prying

Specifications:

- Current rating: 3 A / AC,DC (AWG #22)
- Voltage rating: 250 V AC/DC
- Temperature range: -25°C ~ +105°C
(including temperature rise in applying electrical current)
- Contact resistance: Initial value/ 20mΩ max
Insulation resistance: 1000 MΩ min
Withstanding voltage: 1000 VAC/minute
Applicable wire: Conductor size/ AWG#26~#22
Insulation O.D./ 1.1 to 1.60 mm
- * Compliant with RoHS2/ REACH
- * Refer to "General Instruction and Notice when using Terminals and Connectors"
- * Contact CSG for details

Material:

Housing: PA66/UL94-V0;Color:White
Terminal: Phosphor/ Tin-plated
DIP Wafer Housing:
PA66/PA46,UL94-V0;Color:White/Beige/Natural
DIP Wafer Pin: Brass/ Tin-plated
SMT Wafer Housing: LCP,UL94-V0;Color:Natural
SMT Wafer Pin: Brass/ Tin-plated
SMT Wafer Fixed Foot: Brass/ Tin-plated

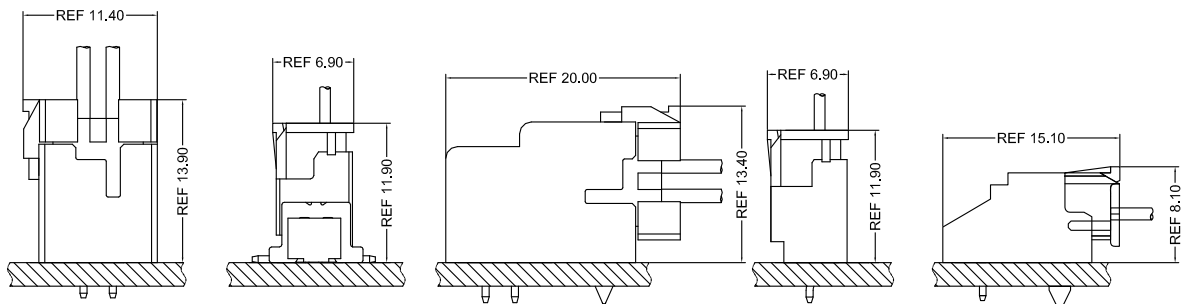

- Note: 1. The above figure is the figure viewed from the connector mounting side.
2. Tolerances are non-cumulative: ± 0.08 mm for all centers.
3. The dimensions above should serve as a guideline. Contact CSG for details.

CSG

A2508 XA/XAD

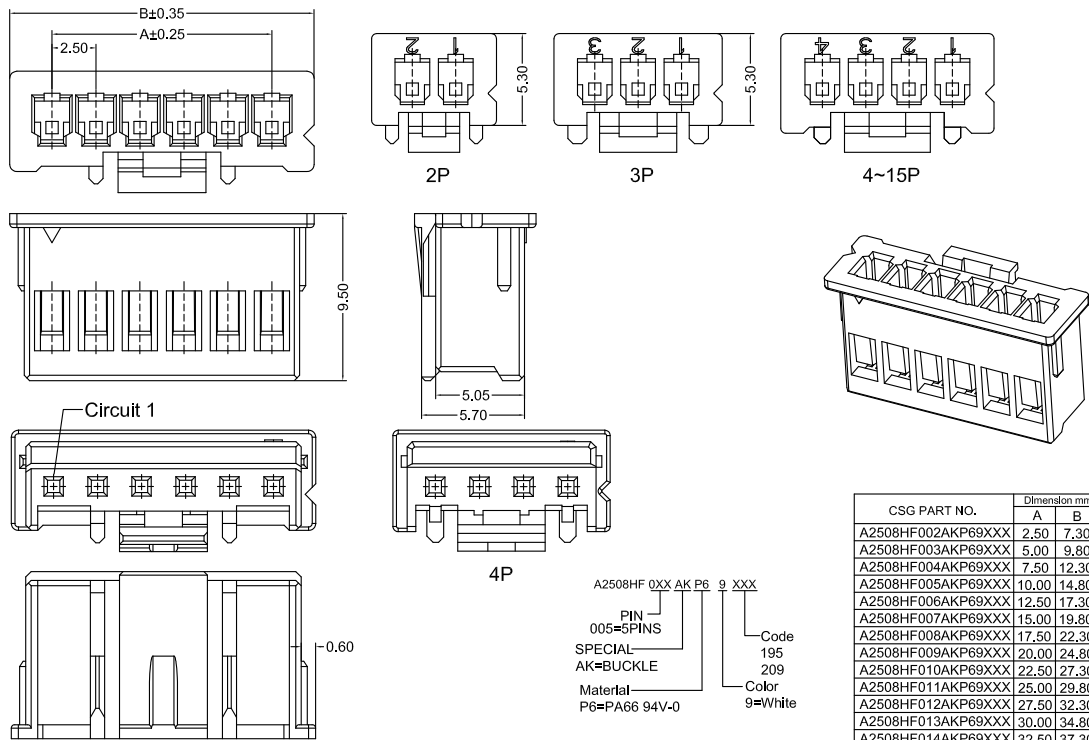

CSG PART NO.	Dimension mm		Q'ty/BAG
	A	B	
A2508HF002AKP69XXX	2.50	7.30	1000PCS
A2508HF003AKP69XXX	5.00	9.80	1000PCS
A2508HF004AKP69XXX	7.50	12.30	1000PCS
A2508HF005AKP69XXX	10.00	14.80	1000PCS
A2508HF006AKP69XXX	12.50	17.30	1000PCS
A2508HF007AKP69XXX	15.00	19.80	1000PCS
A2508HF008AKP69XXX	17.50	22.30	1000PCS
A2508HF009AKP69XXX	20.00	24.80	1000PCS
A2508HF010AKP69XXX	22.50	27.30	1000PCS
A2508HF011AKP69XXX	25.00	29.80	1000PCS
A2508HF012AKP69XXX	27.50	32.30	1000PCS
A2508HF013AKP69XXX	30.00	34.80	1000PCS
A2508HF014AKP69XXX	32.50	37.30	1000PCS
A2508HF015AKP69XXX	35.00	39.80	1000PCS

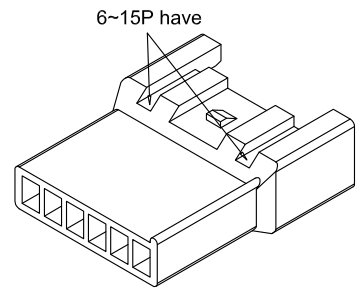
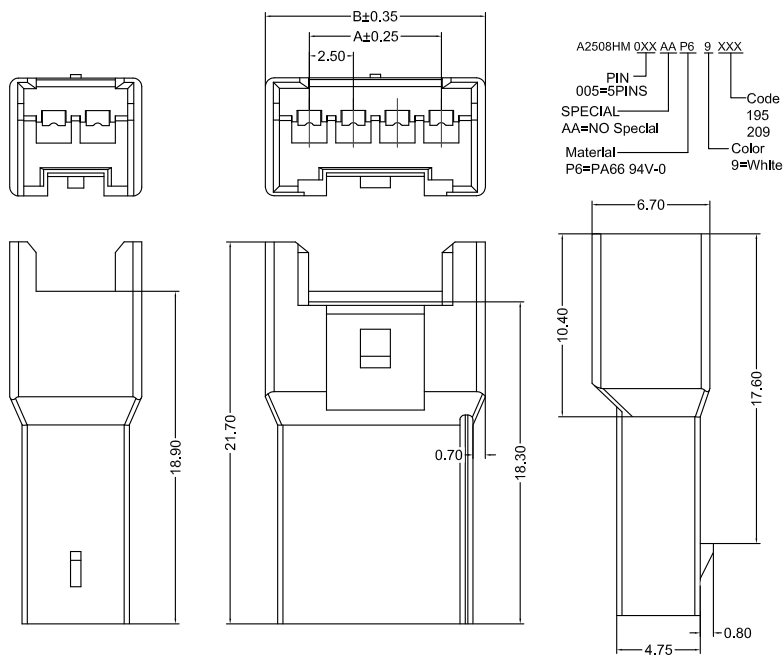

CSG PART NO.	Dimension mm		Q'ty/BAG
	A	B	
A2508HM002AAP69XXX	2.50	7.30	1000PCS
A2508HM003AAP69XXX	5.00	9.80	1000PCS
A2508HM004AAP69XXX	7.50	12.30	1000PCS
A2508HM005AAP69XXX	10.00	14.80	1000PCS
A2508HM006AAP69XXX	12.50	17.30	1000PCS
A2508HM007AAP69XXX	15.00	19.80	1000PCS
A2508HM008AAP69XXX	17.50	22.30	1000PCS
A2508HM009AAP69XXX	20.00	24.80	1000PCS
A2508HM010AAP69XXX	22.50	27.30	1000PCS
A2508HM011AAP69XXX	25.00	29.80	1000PCS
A2508HM012AAP69XXX	27.50	32.30	1000PCS
A2508HM013AAP69XXX	30.00	34.80	1000PCS
A2508HM014AAP69XXX	32.50	37.30	1000PCS
A2508HM015AAP69XXX	35.00	39.80	1000PCS



A2508 XA/XAD

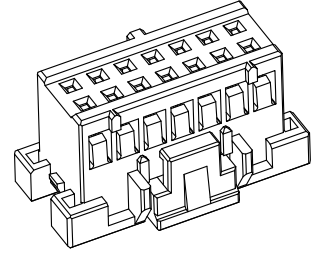
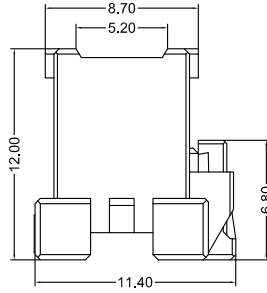
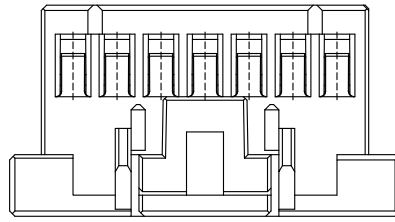
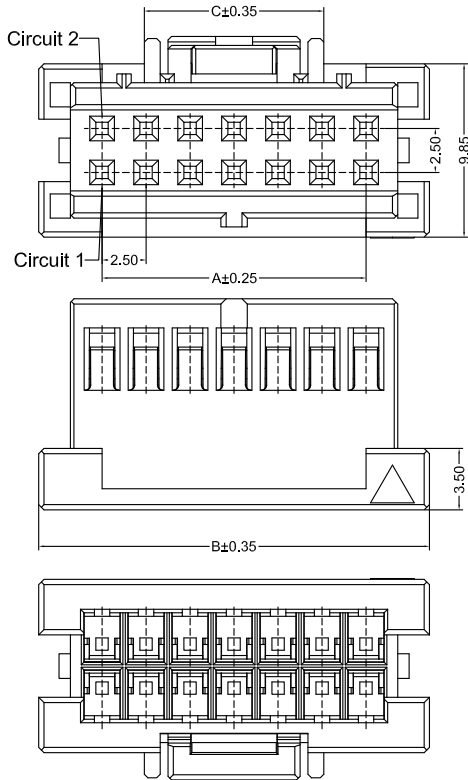

A2508HF 2XX AK P6 9 XXX
 PIN
 205=2X5PINS
 SPECIAL
 AK=BUCKLE
 Material
 P6=PA66 94V-0
 Code
 195
 209
 Color
 9=White

CSG PART NO.	Dimension mm			Q'ty/BAG
	A	B	C	
A2508HF204AKP69XXX	7.50	14.90	9.60	1000PCS
A2508HF205AKP69XXX	10.00	17.40	9.60	1000PCS
A2508HF206AKP69XXX	12.50	19.90	10.20	1000PCS
A2508HF207AKP69XXX	15.00	22.40	10.20	1000PCS
A2508HF208AKP69XXX	17.50	24.90	10.20	1000PCS
A2508HF209AKP69XXX	20.00	27.40	17.70	1000PCS
A2508HF210AKP69XXX	22.50	29.90	17.70	1000PCS
A2508HF211AKP69XXX	25.00	32.40	17.70	1000PCS
A2508HF212AKP69XXX	27.50	34.90	17.70	1000PCS
A2508HF213AKP69XXX	30.00	37.40	17.70	1000PCS
A2508HF214AKP69XXX	32.50	39.90	17.70	1000PCS
A2508HF220AKP69XXX	47.50	54.90	17.70	1000PCS

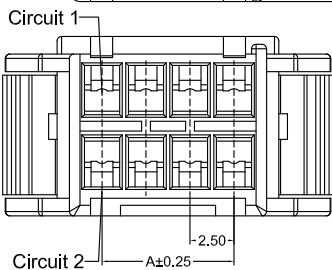
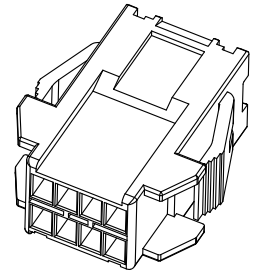
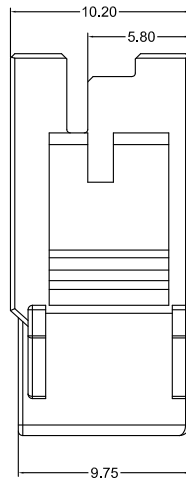
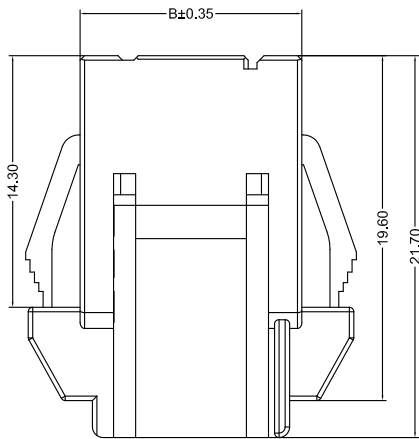

A2508HM 2XX AA P6 9 195
 PIN
 205=2X5PINS
 SPECIAL
 AA=NO Spectral
 Material
 P6=PA66 94V-0
 Code
 195
 Color
 9=White

CSG PART NO.	Dimension mm		Q'ty/BAG
	A	B	
A2508HM004AAP69195	7.50	14.70	1000PCS
A2508HM005AAP69195	10.00	17.20	1000PCS
A2508HM006AAP69195	12.50	19.70	1000PCS
A2508HM007AAP69195	15.00	22.20	1000PCS
A2508HM008AAP69195	17.50	24.70	1000PCS
A2508HM009AAP69195	20.00	27.20	1000PCS
A2508HM010AAP69195	22.50	29.70	1000PCS
A2508HM011AAP69195	25.00	32.20	1000PCS
A2508HM012AAP69195	27.50	34.70	1000PCS
A2508HM013AAP69195	30.00	37.20	1000PCS
A2508HM014AAP69195	32.50	39.70	1000PCS
A2508HM020AAP69195	47.50	54.70	1000PCS



A2508 XA/XAD

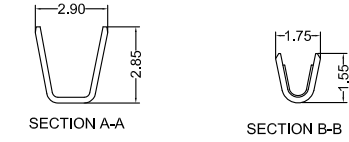
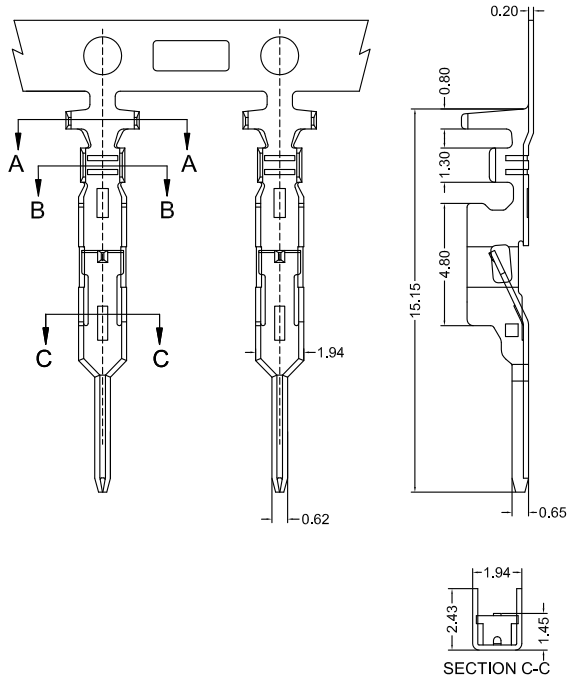

A2508 F 0 A TP XXX

Type
F=Male Terminal

SPECIAL
O=NO Special

Material
A=Phosphor

Finish
TP=Tin-Plated

Code
209
195

CSG PART NO.	Wire Range	Insulation O.D.	Qty/Reel
A2508F0ATP195	AWG#22-#26	1.60mm(max)	7000PCS
A2508F0ATP209	AWG#22-#26	1.60mm(max)	7500PCS

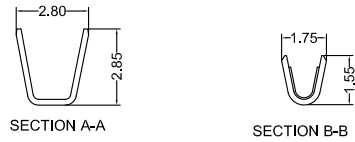
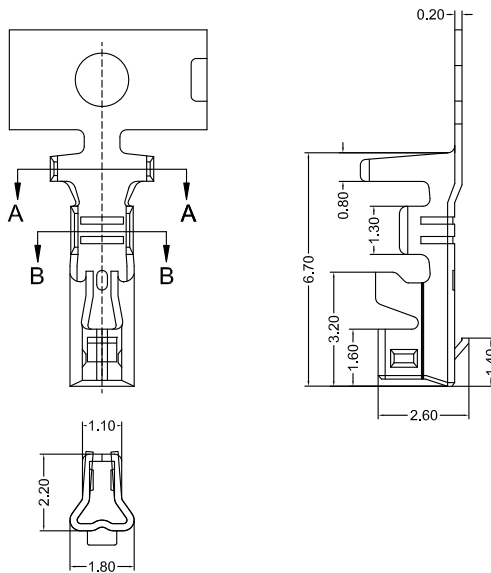

A2508 M 0 A TP 209

Type
M=Female Terminal

SPECIAL
O=NO Special

Material
A=Phosphor

Finish
TP=Tin-Plated

Code
209

CSG PART NO.	Wire Range	Insulation O.D.	Qty/Reel
A2508M0ATP209	AWG#22-#28	1.60mm(max)	7500PCS



A2508 XA/XAD

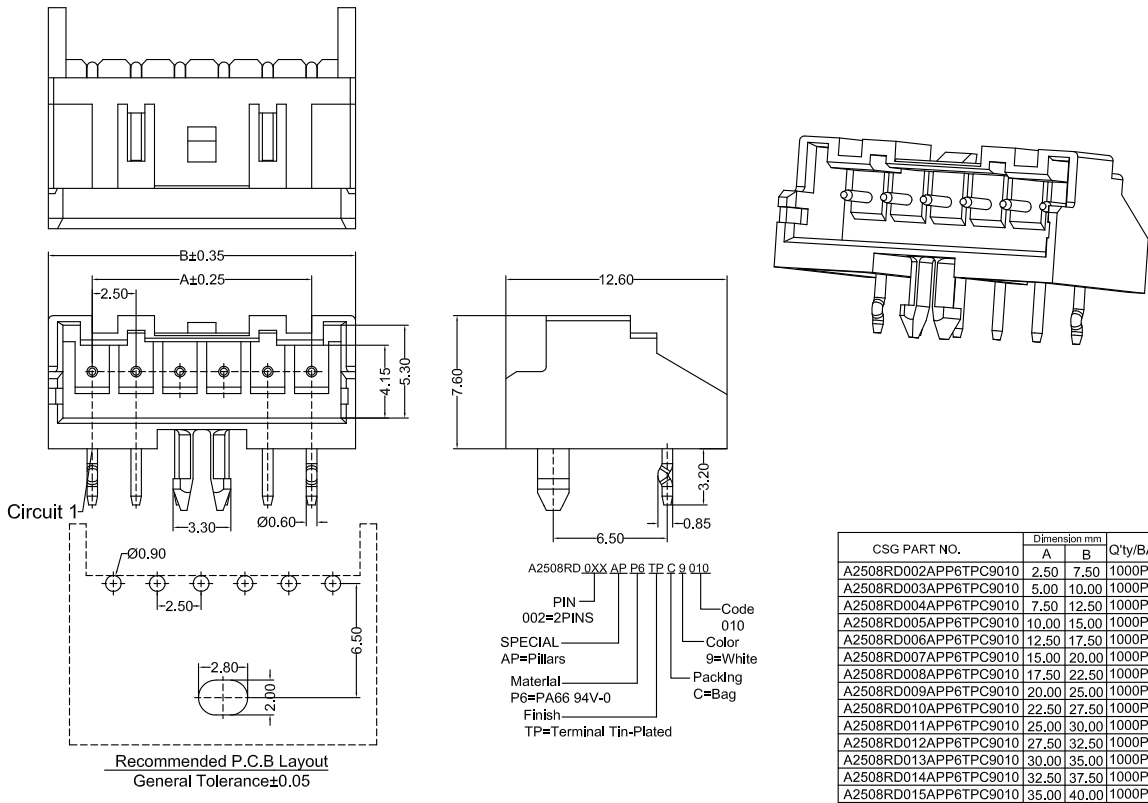

CSG PART NO.	Dimension mm		Q'ty/BAG
	A	B	
A2508RD002APP6TPC9010	2.50	7.50	1000PCS
A2508RD003APP6TPC9010	5.00	10.00	1000PCS
A2508RD004APP6TPC9010	7.50	12.50	1000PCS
A2508RD005APP6TPC9010	10.00	15.00	1000PCS
A2508RD006APP6TPC9010	12.50	17.50	1000PCS
A2508RD007APP6TPC9010	15.00	20.00	1000PCS
A2508RD008APP6TPC9010	17.50	22.50	1000PCS
A2508RD009APP6TPC9010	20.00	25.00	1000PCS
A2508RD010APP6TPC9010	22.50	27.50	1000PCS
A2508RD011APP6TPC9010	25.00	30.00	1000PCS
A2508RD012APP6TPC9010	27.50	32.50	1000PCS
A2508RD013APP6TPC9010	30.00	35.00	1000PCS
A2508RD014APP6TPC9010	32.50	37.50	1000PCS
A2508RD015APP6TPC9010	35.00	40.00	1000PCS

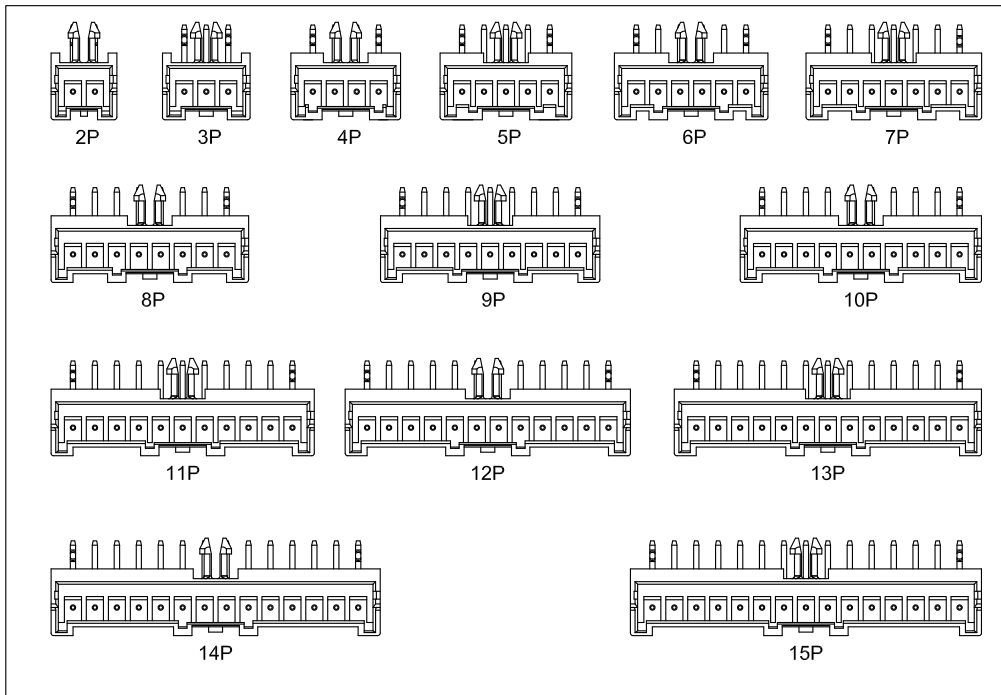

A2508 XA/XAD

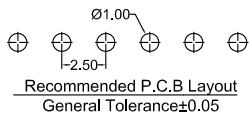
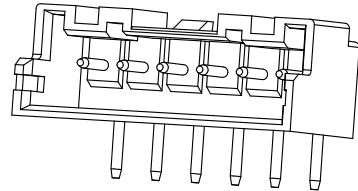
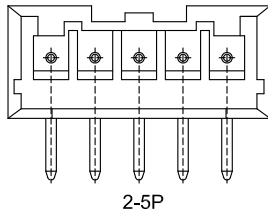
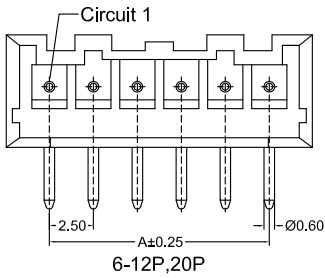
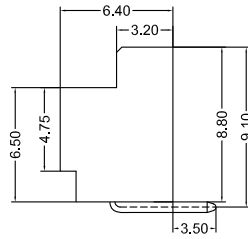
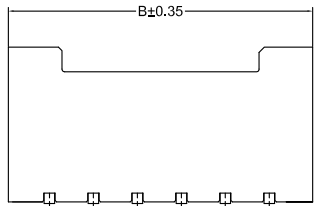

A2508RD_0XX AA P6 TP C 9 209

PIN
002=2PINS

SPECIAL
AA=NO Special

Material
P6=PA66 94V-0

Finish
TP=Terminal Tin-Plated

Code
209

Color
9=White

Packing
C=Bag

CSG PART NO.	Dimension mm		Q'ty/BAG
	A	B	
A2508RD002AAP6TPC9209	2.50	7.50	1000PCS
A2508RD003AAP6TPC9209	5.00	10.00	1000PCS
A2508RD004AAP6TPC9209	7.50	12.50	1000PCS
A2508RD005AAP6TPC9209	10.00	15.00	1000PCS
A2508RD006AAP6TPC9209	12.50	17.50	1000PCS
A2508RD007AAP6TPC9209	15.00	20.00	1000PCS
A2508RD008AAP6TPC9209	17.50	22.50	1000PCS
A2508RD009AAP6TPC9209	20.00	25.00	1000PCS
A2508RD010AAP6TPC9209	22.50	27.50	1000PCS
A2508RD011AAP6TPC9209	25.00	30.00	1000PCS
A2508RD012AAP6TPC9209	27.50	32.50	1000PCS
A2508RD020AAP6TPC9209	47.50	52.50	1000PCS

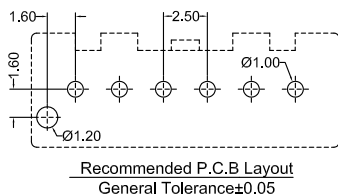
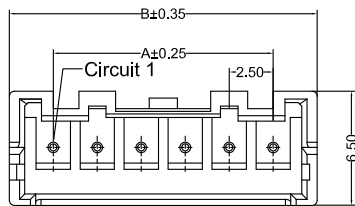
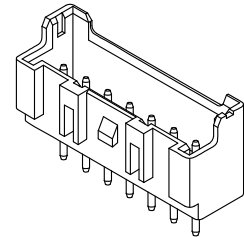
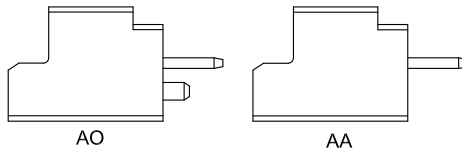
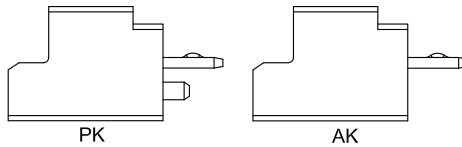
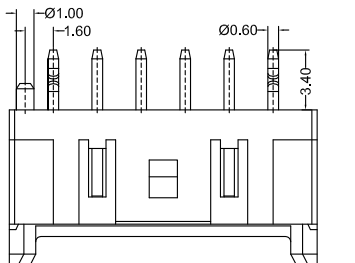

A2508VD_0XX XX P6 TP C X XXX

PIN
002=2PINS

SPECIAL
AA=NO K
AK=K Feet
AO=Orientation NO K
PK=Orientation K

Material
P6=PA66 94V-0

Finish
TP=Terminal Tin-Plated

Code
209

Color
9=White

Packing
C=Belge
C=Bag

CSG PART NO.	Dimension mm		Q'ty/BAG
	A	B	
A2508VD002XXP6TPCXXXX	2.50	7.50	1000PCS
A2508VD003XXP6TPCXXXX	5.00	10.00	1000PCS
A2508VD004XXP6TPCXXXX	7.50	12.50	1000PCS
A2508VD005XXP6TPCXXXX	10.00	15.00	1000PCS
A2508VD006XXP6TPCXXXX	12.50	17.50	1000PCS
A2508VD007XXP6TPCXXXX	15.00	20.00	1000PCS
A2508VD008XXP6TPCXXXX	17.50	22.50	1000PCS
A2508VD009XXP6TPCXXXX	20.00	25.00	1000PCS
A2508VD010XXP6TPCXXXX	22.50	27.50	1000PCS
A2508VD011XXP6TPCXXXX	25.00	30.00	1000PCS
A2508VD012XXP6TPCXXXX	27.50	32.50	1000PCS
A2508VD013XXP6TPCXXXX	30.00	35.00	1000PCS
A2508VD014XXP6TPCXXXX	32.50	37.50	1000PCS
A2508VD015XXP6TPCXXXX	35.00	40.00	1000PCS
A2508VD020XXP6TPCXXXX	47.50	52.50	1000PCS



A2508 XA/XAD

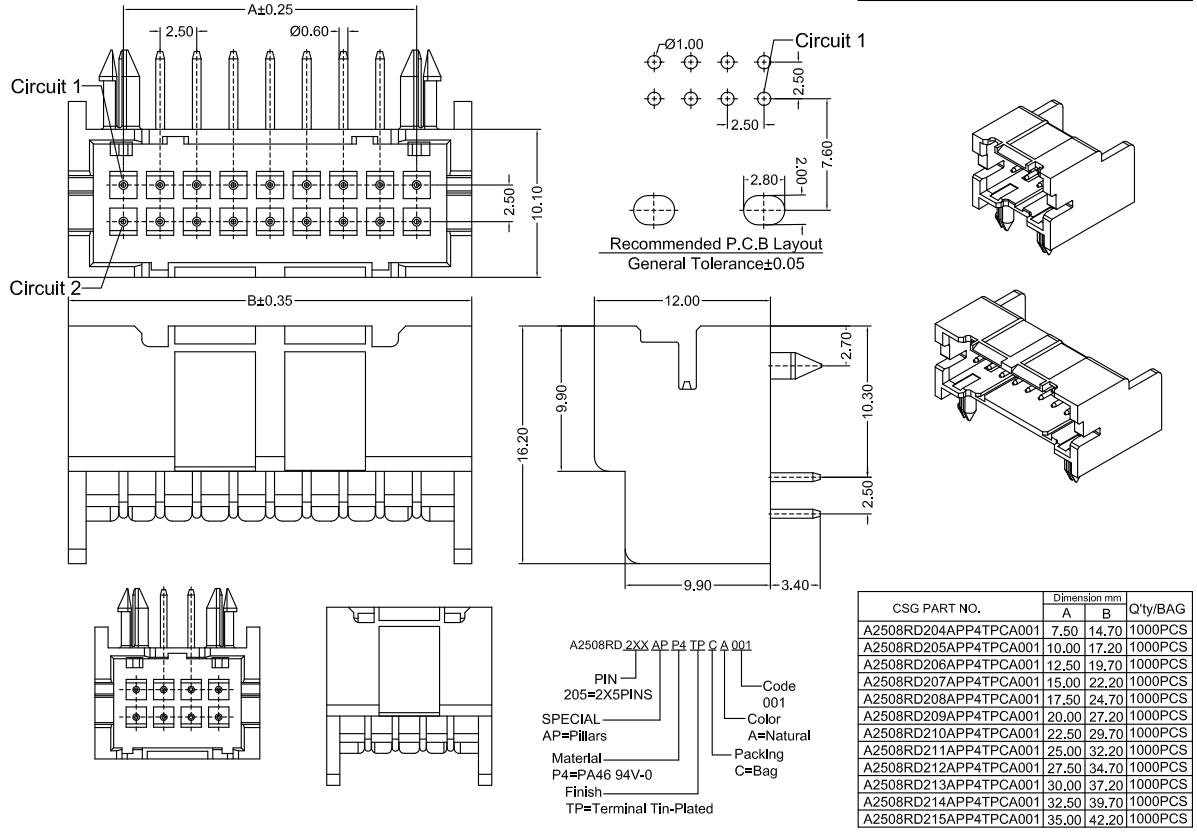
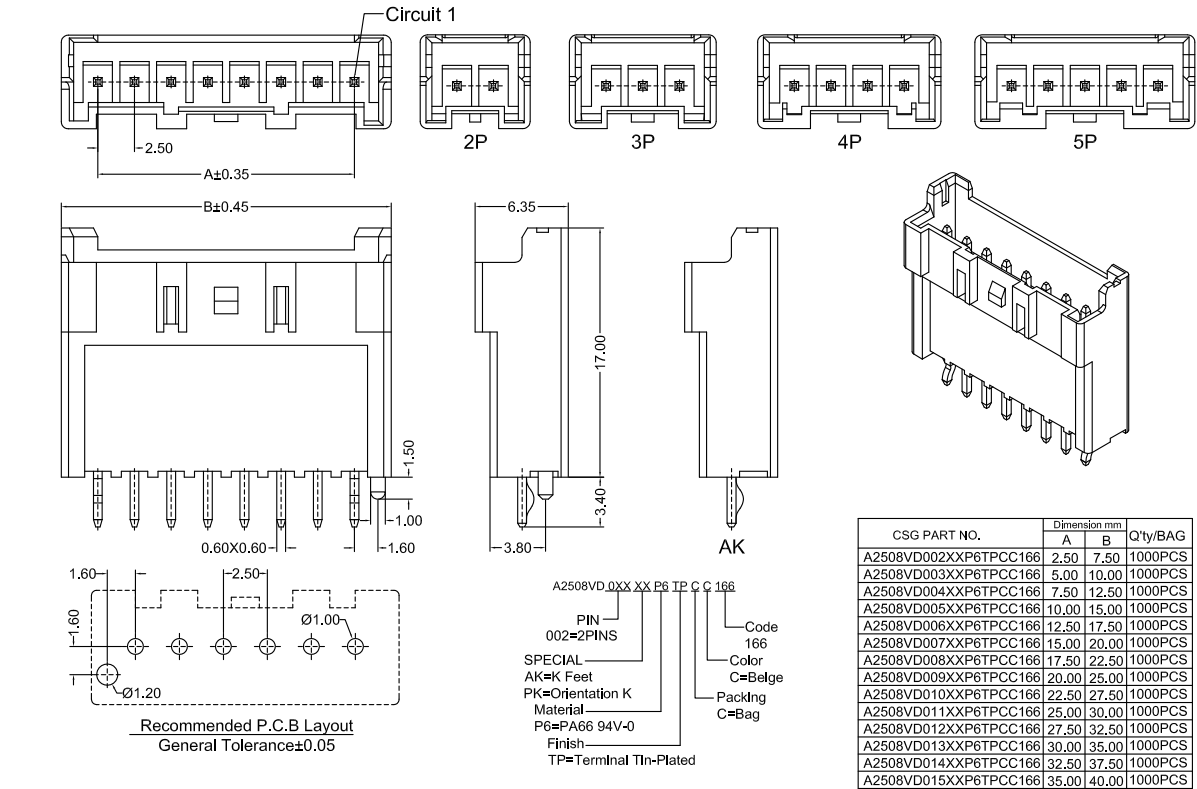

A2508 XA/XAD

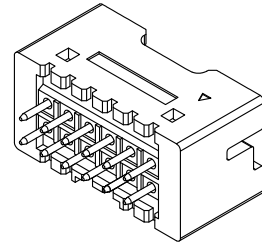
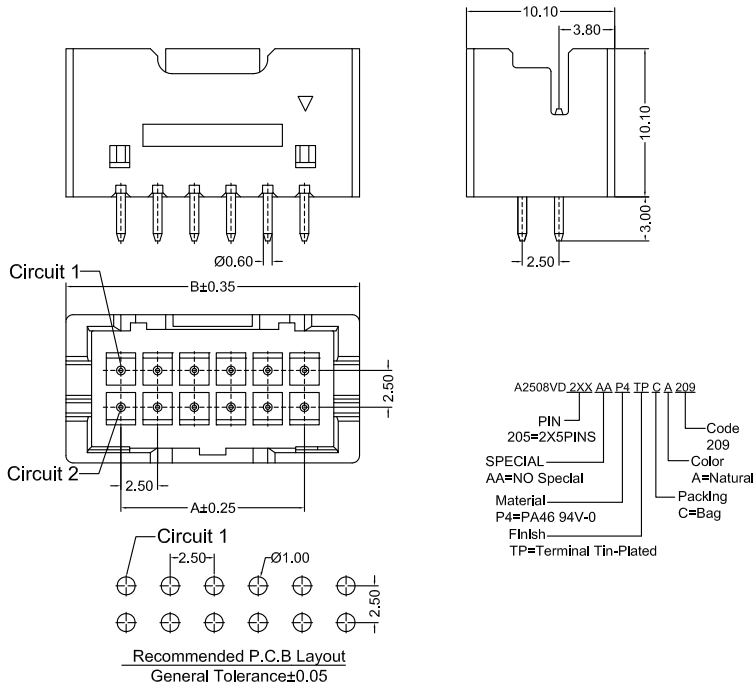

CSG PART NO.	Dimension mm		Q'ty/BAG
	A	B	
A2508VD204AAP4TPCA209	7.50	15.00	1000PCS
A2508VD205AAP4TPCA209	10.00	17.50	1000PCS
A2508VD206AAP4TPCA209	12.50	20.00	1000PCS
A2508VD207AAP4TPCA209	15.00	22.50	1000PCS
A2508VD208AAP4TPCA209	17.50	25.00	1000PCS
A2508VD209AAP4TPCA209	20.00	27.50	1000PCS
A2508VD210AAP4TPCA209	22.50	30.00	1000PCS
A2508VD211AAP4TPCA209	25.00	32.50	1000PCS
A2508VD212AAP4TPCA209	27.50	35.00	1000PCS
A2508VD213AAP4TPCA209	30.00	37.50	1000PCS
A2508VD214AAP4TPCA209	32.50	40.00	1000PCS
A2508VD215AAP4TPCA209	35.00	42.50	1000PCS

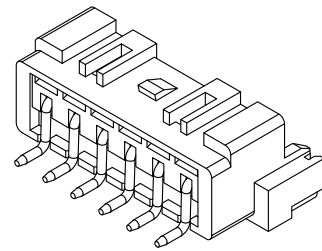
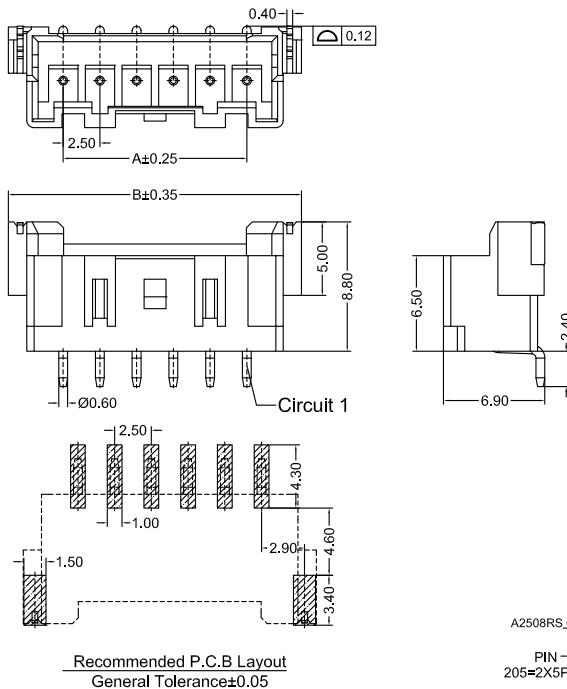

CSG PART NO.	Dimension mm		Q'ty/BAG
	A	B	
A2508RS002AA6TTPBA209	2.50	10.00	1000PCS
A2508RS003AA6TTPBA209	5.00	12.50	1000PCS
A2508RS004AA6TTPBA209	7.50	15.00	1000PCS
A2508RS005AA6TTPBA209	10.00	17.50	1000PCS
A2508RS006AA6TTPBA209	12.50	20.00	1000PCS
A2508RS007AA6TTPBA209	15.00	22.50	1000PCS
A2508RS008AA6TTPBA209	17.50	25.00	1000PCS
A2508RS009AA6TTPBA209	20.00	27.50	1000PCS
A2508RS010AA6TTPBA209	22.50	30.00	1000PCS
A2508RS011AA6TTPBA209	25.00	32.50	1000PCS
A2508RS012AA6TTPBA209	27.50	35.00	1000PCS
A2508RS013AA6TTPBA209	30.00	37.50	1000PCS
A2508RS014AA6TTPBA209	32.50	40.00	1000PCS
A2508RS015AA6TTPBA209	35.00	42.50	1000PCS



A2508 XA/XAD

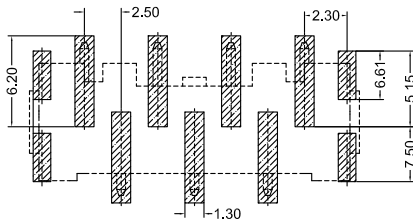
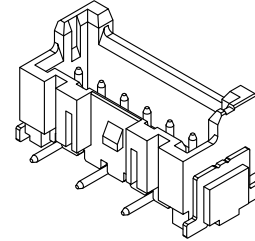
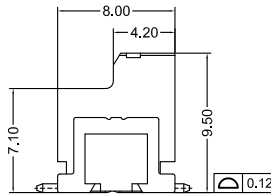
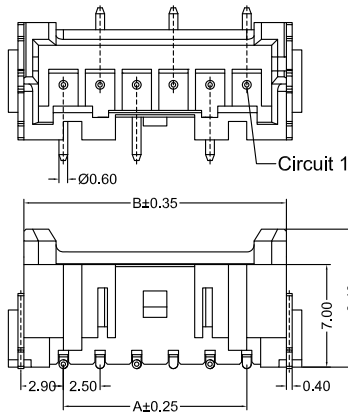

Recommended P.C.B. Layout
General Tolerance±0.05

A2508VS_0XX AA 6T TP B Δ 209

PIN
205=2X5PINS

SPECIAL

AA=NO Spedal

Materjal
6T=PA6T 94V-0

Finlsh

TP=Terminal Tin-Plated

Code
209

Color

A=Natural

Packng
B=Reel Packing

CSG PART NO.	Dimension mm		Q'ty/BAG
	A	B	
A2508VS002AA6TTPBA209	2.50	7.50	1000PCS
A2508VS003AA6TTPBA209	5.00	10.00	1000PCS
A2508VS004AA6TTPBA209	7.50	12.50	1000PCS
A2508VS005AA6TTPBA209	10.00	15.00	1000PCS
A2508VS006AA6TTPBA209	12.50	17.50	1000PCS
A2508VS007AA6TTPBA209	15.00	20.00	1000PCS
A2508VS008AA6TTPBA209	17.50	22.50	1000PCS
A2508VS009AA6TTPBA209	20.00	25.00	1000PCS
A2508VS010AA6TTPBA209	22.50	27.50	1000PCS
A2508VS011AA6TTPBA209	25.00	30.00	1000PCS
A2508VS012AA6TTPBA209	27.50	32.50	1000PCS
A2508VS013AA6TTPBA209	30.00	35.00	1000PCS
A2508VS014AA6TTPBA209	32.50	37.50	1000PCS
A2508VS015AA6TTPBA209	35.00	40.00	1000PCS