

# C4200 MX 4.20 CONNECTOR

4.20mm Pitch/Disconnectable Crimp style connectors

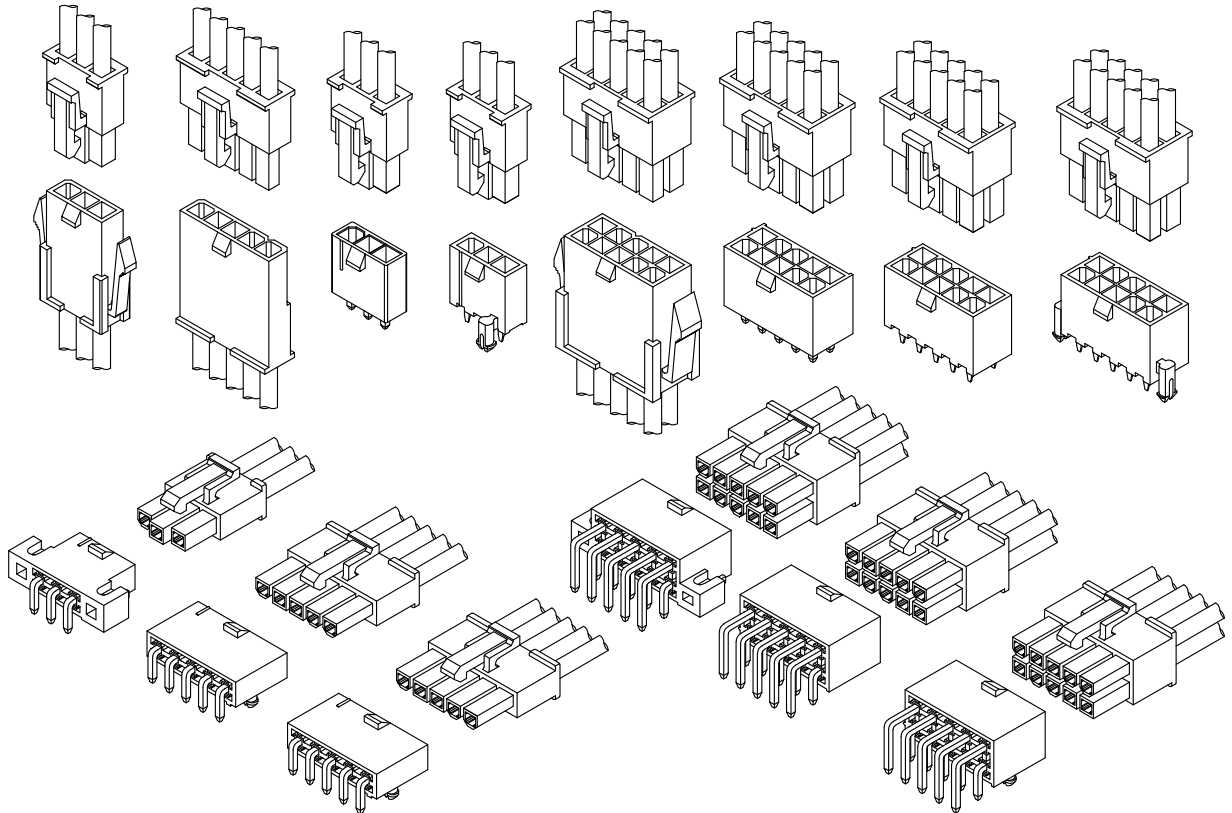

- Secure locking structure
- Low insertion force
- Suction area for picking up
- Improvement of engagement with prying

### Specifications:

- Current rating: 7.0~9.0 A / AC,DC
- Voltage rating: 600 V AC/DC
- Temperature range: -25°C ~ +105°C  
(including temperature rise in applying electrical current)
- Contact resistance: Initial value/ 20m Ω max
- Insulation resistance: 1000 M Ω min
- Withstanding voltage: 1500 VAC/minute
- Applicable wire: Conductor size/ AWG#24~#16  
Insulation O.D./ 1.30 to 4.30 mm
- \* Compliant with RoHS2/ REACH
- \* Refer to "General Instruction and Notice when using Terminals and Connectors"
- \* Contact CSG for details

Material: \_\_\_\_\_

Housing: PA66/UL94-V0/ V2;Color:Translucent/ Black/ White

Terminal: Phosphor/Brass C1100/ Gold-Plated/ Tin-plated  
DIP Wafer Housing: PA66/ PA9T/,UL94-V0/ V2;Color: Translucent/ Black/ White

DIP/ SMT Wafer Pin: Brass/ C1100 Tin-plated/ Gold-Plated  
SMT Wafer Housing: PA9T/,UL94-V0;Color:Black/ White

- Note: 1. The above figure is the figure viewed from the connector mounting side.  
2. Tolerances are non-cumulative: ±0.08 mm for all centers.  
3. The dimensions above should serve as a guideline. Contact CSG for details.



# C4200 MX 4.20

## WIRE TO WIRE

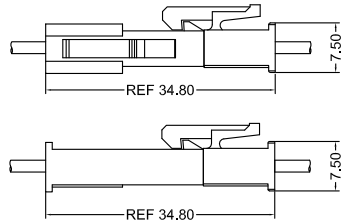

Single Row

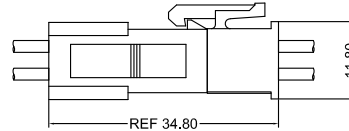

Dual Row

## WIRE TO BOARD

### Single Row:3P

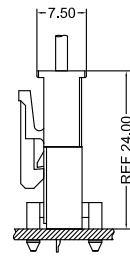
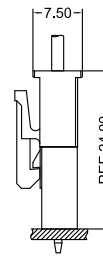
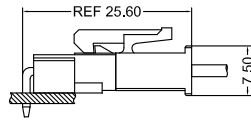
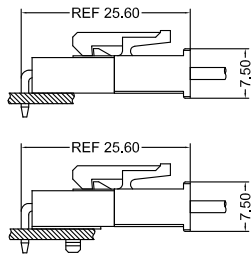

## WIRE TO BOARD

### Single Row:2P,4P,5P,6P

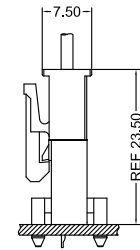
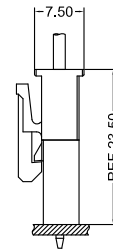
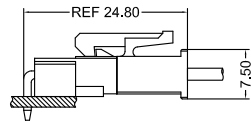
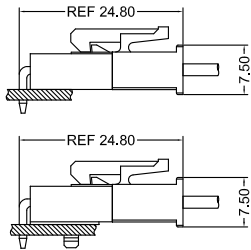

## WIRE TO BOARD

### Dual Row:2X1P~2X12P

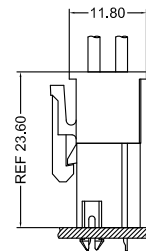
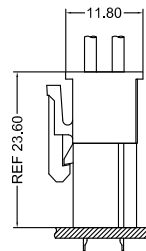
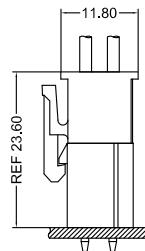
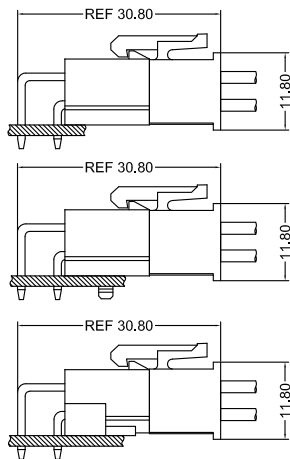

# C4200 MX 4.20

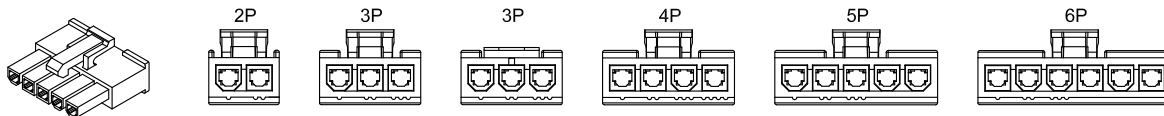

C4200HF0XX

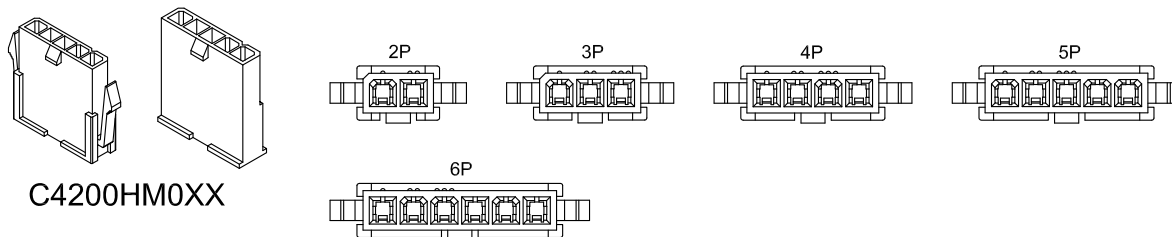

C4200HM0XX

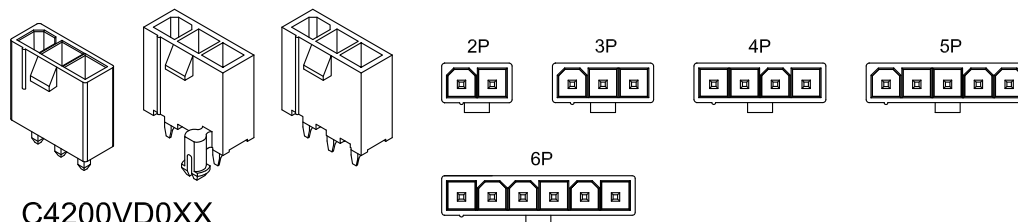

C4200VD0XX

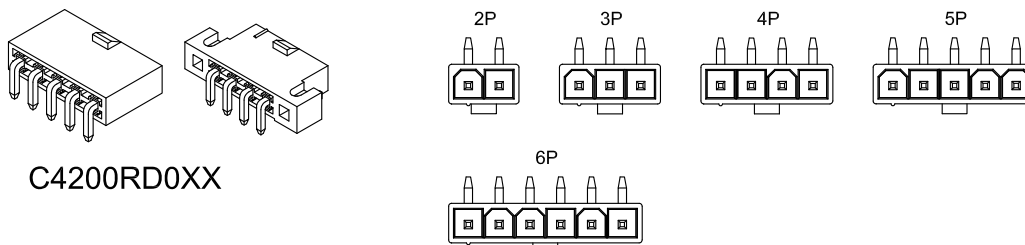

C4200RD0XX

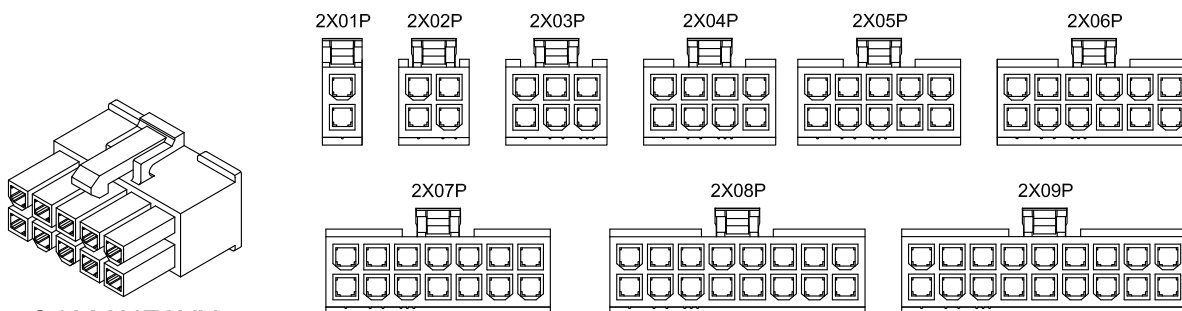

C4200HF2XX

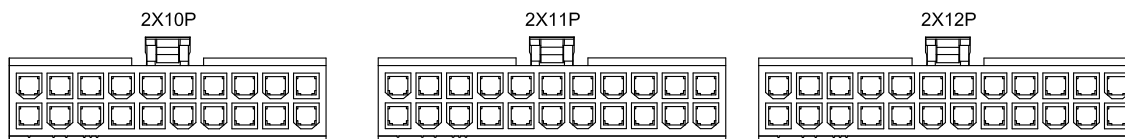

# C4200 MX 4.20

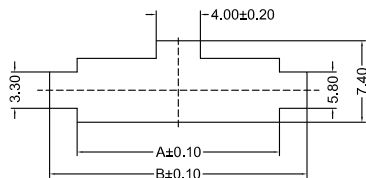
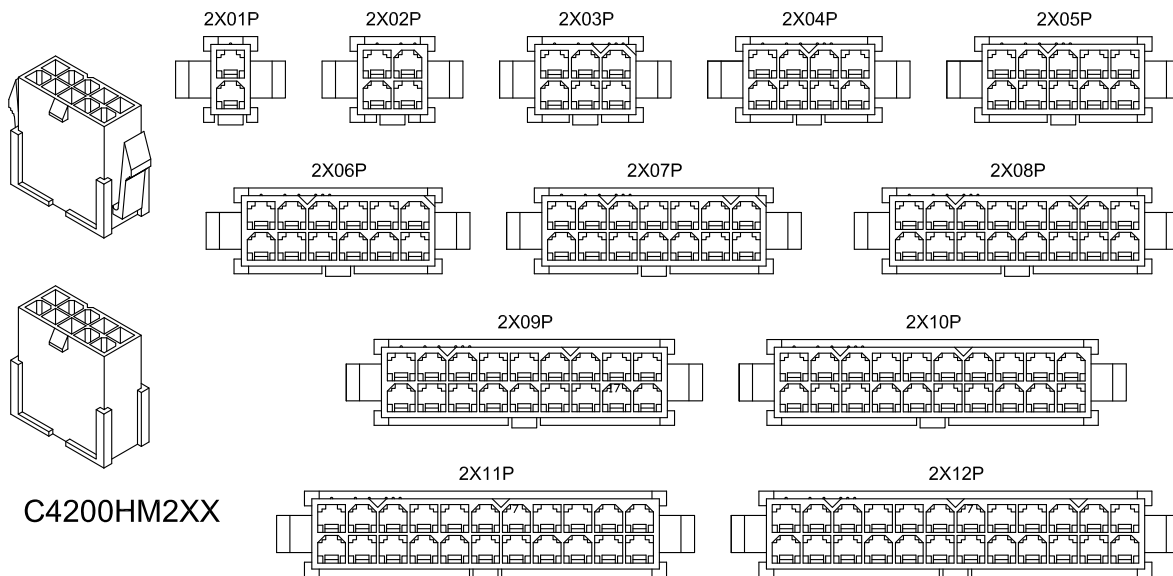
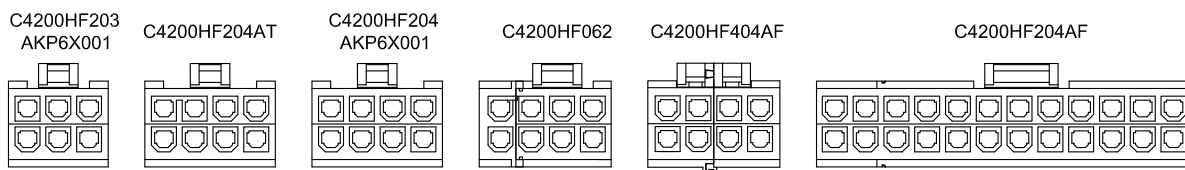

**SINGLE ROW**  
**RECOMMENDED PANEL CUT-OUT**  
 (DESIGNED FOR 0.80mm TO 2.00mm THICK  
 STAMPED PANEL OR PRINTED CIRCUIT BOARD)

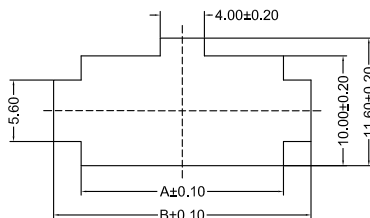

**DUAL ROW**  
**RECOMMENDED PANEL CUT-OUT**  
 (DESIGNED FOR 0.80mm TO 2.00mm THICK  
 STAMPED PANEL OR PRINTED CIRCUIT BOARD)

CSG PART NO.	Dimension mm	
	A	B
C4200HM002ADP6X005	5.80	10.80
C4200HM003ADP6X005	10.00	15.00
C4200HM004ADP6X005	14.20	19.20
C4200HM005ADP6X005	18.40	23.40
C4200HM006ADP6X005	22.60	27.60
C4200HM007ADP6X005	26.80	31.80
C4200HM008ADP6X005	31.00	36.00
C4200HM009ADP6X005	35.20	40.20
C4200HM010ADP6X005	39.40	44.40
C4200HM011ADP6X005	43.60	48.60
C4200HM012ADP6X005	47.80	52.80
C4200HM201ADP6X005	52.00	57.00
C4200HM202ADP6X005	56.20	61.20
C4200HM203ADP6X005	60.40	65.40
C4200HM204ADP6X005	64.60	69.60
C4200HM205ADP6X005	68.80	73.80
C4200HM206ADP6X005	73.00	78.00
C4200HM207ADP6X005	77.20	82.20
C4200HM208ADP6X005	81.40	86.40
C4200HM209ADP6X005	85.60	90.60
C4200HM210ADP6X005	89.80	94.80
C4200HM211ADP6X005	94.00	99.00
C4200HM212ADP6X005	98.20	103.20



# C4200 MX 4.20

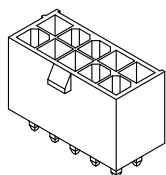

C4200VD2XXAA

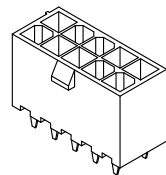

C4200VD2XXAI

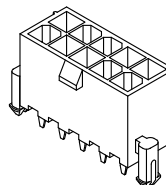

C4200VD2XXAP  
C4200VD2XXPL  
C4200VD2XXPR

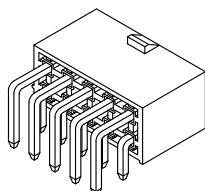
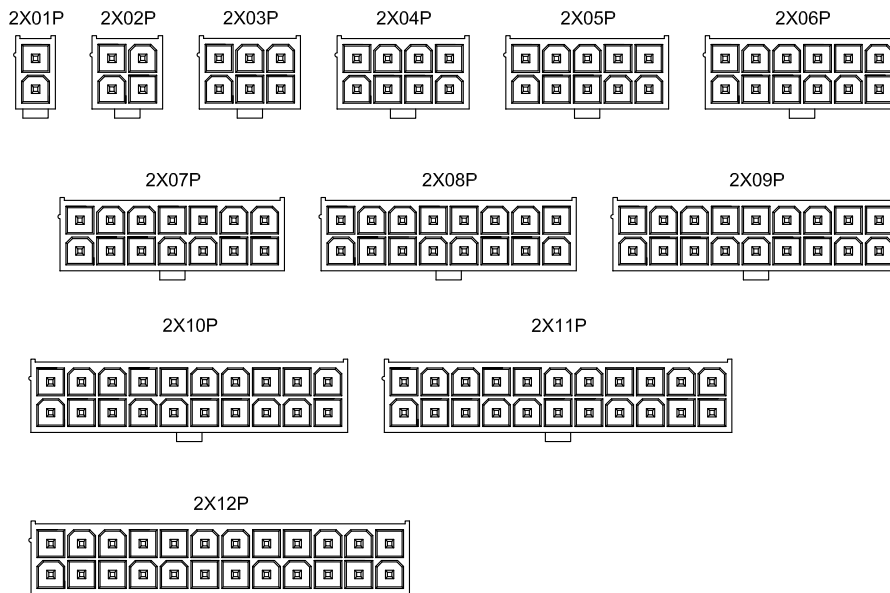

C4200RD2XXAA

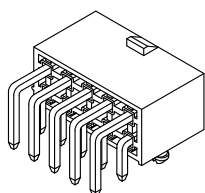

C4200RD2XXAP

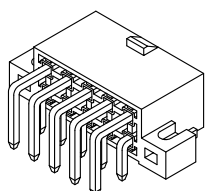

C4200RD2XXAS

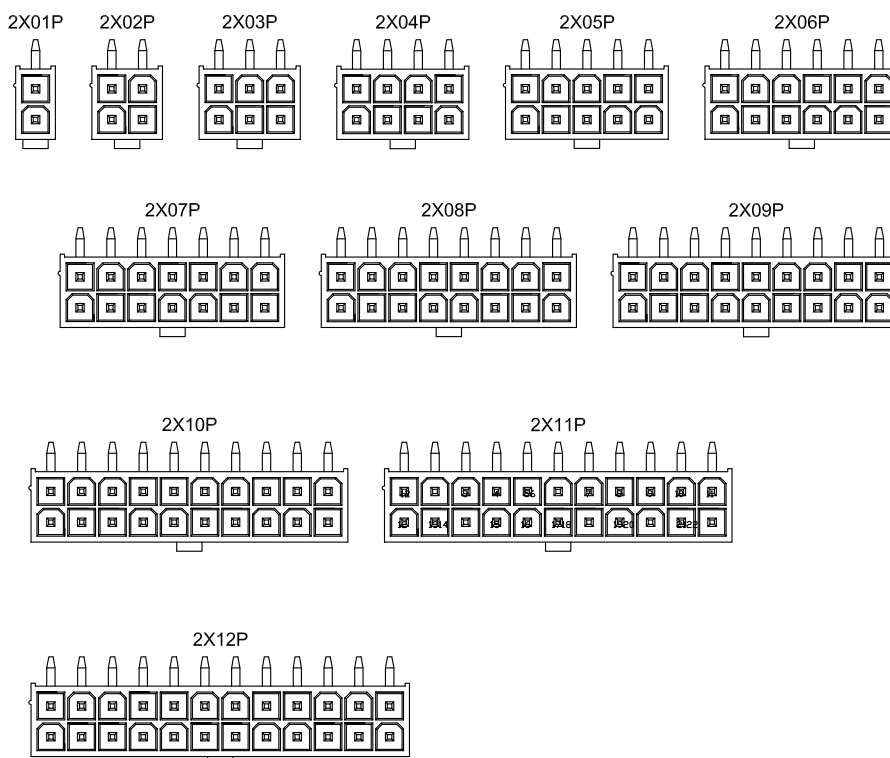

# C4200 MX 4.20

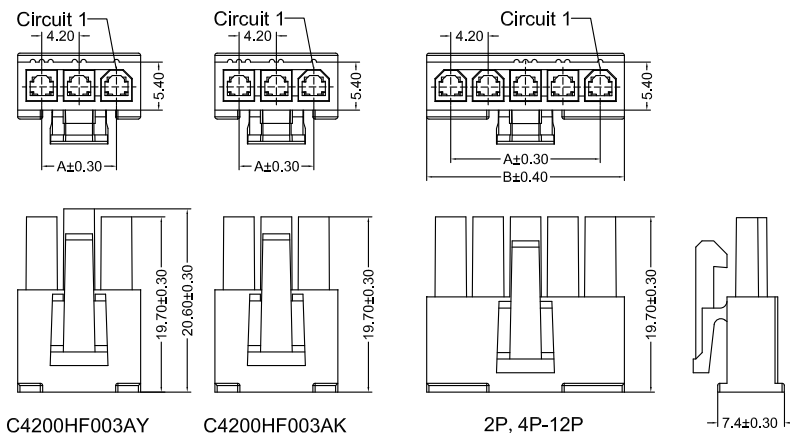

C4200HF003AY

C4200HF003AK

2P, 4P-12P

-7.4±0.30

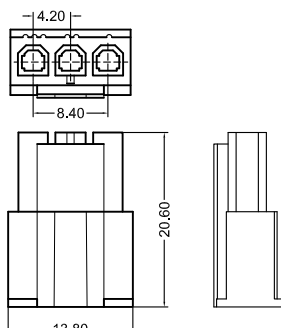

C4200HF003HPP67005

C4200HF 0XX XX P6 X 005  
 PIN  
 005=5PINS  
 SPECIAL  
 AK=BUCKLE  
 AY=PIN Bit is increased  
 HP=HP Specific  
 Material  
 P6=PA66 94V-2/0

Code  
 005  
 Color  
 0=Black  
 B=Translucent  
 9=White  
 7=Purple

CSG PART NO.	Dimension mm		Q'ty/BAG
	A	B	
C4200HF002AKP6X005	4.20	9.60	1000PCS
C4200HF003AKP6X005	8.40	13.80	1000PCS
C4200HF003AYP6X005	8.40	13.80	1000PCS
C4200HF004AKP6X005	12.60	18.00	1000PCS
C4200HF005AKP6X005	16.80	22.20	1000PCS
C4200HF006AKP6X005	21.00	26.40	1000PCS
C4200HF007AKP6X005	25.20	30.60	1000PCS
C4200HF008AKP6X005	29.40	34.80	1000PCS
C4200HF009AKP6X005	33.60	39.00	1000PCS
C4200HF010AKP6X005	37.80	43.20	1000PCS
C4200HF011AKP6X005	42.00	47.40	1000PCS
C4200HF012AKP6X005	46.20	51.60	1000PCS

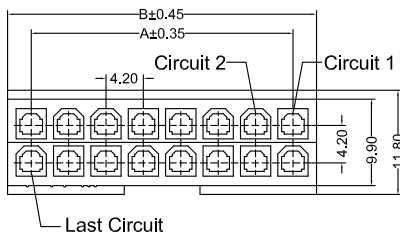
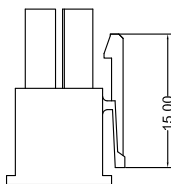
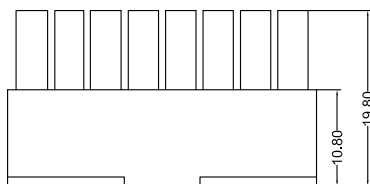
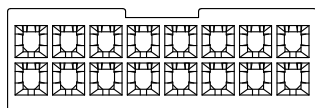

C4200HF 2XX AA P6 X 005  
 PIN  
 205=2X5PINS  
 SPECIAL  
 AA=NO Spectral  
 Material  
 P6=PA66 94-V0/V2

Code  
 005  
 Color  
 0=Black  
 B=Translucent  
 9=White

CSG PART NO.	Dimension mm		Q'ty/BAG
	A	B	
C4200HF202AAP6X005	4.20	9.50	1000PCS
C4200HF203AAP6X005	8.40	13.70	1000PCS
C4200HF204AAP6X005	12.60	17.90	1000PCS
C4200HF205AAP6X005	16.80	22.10	1000PCS
C4200HF206AAP6X005	21.00	26.30	1000PCS
C4200HF207AAP6X005	25.20	30.50	1000PCS
C4200HF208AAP6X005	29.40	34.70	1000PCS
C4200HF209AAP6X005	33.60	38.90	1000PCS
C4200HF210AAP6X005	37.80	43.10	1000PCS
C4200HF211AAP6X005	42.00	47.30	1000PCS
C4200HF212AAP6X005	46.20	51.50	1000PCS



# C4200 MX 4.20

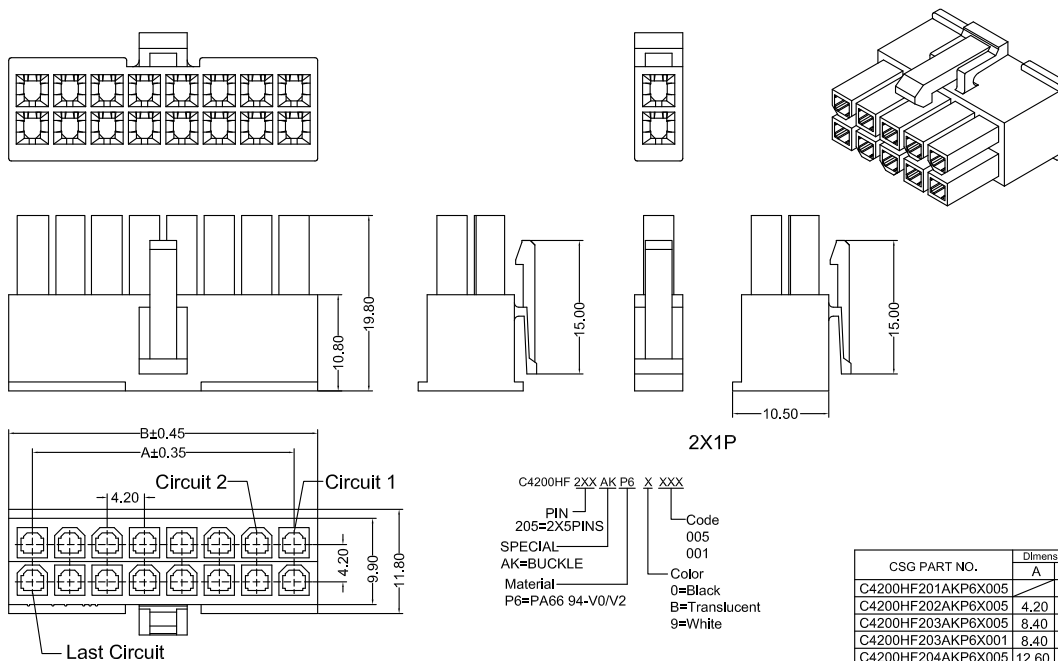

CSG PART NO.	Dimension mm		Qty/BAG
	A	B	
C4200HF201AKP6X005	5.30	1000PCS	
C4200HF202AKP6X005	4.20	9.50	1000PCS
C4200HF203AKP6X005	8.40	13.70	1000PCS
C4200HF203AKP6X001	8.40	13.70	1000PCS
C4200HF204AKP6X005	12.60	17.90	1000PCS
C4200HF204AKP6X001	12.60	17.90	1000PCS
C4200HF205AKP6X005	16.80	22.10	1000PCS
C4200HF206AKP6X005	21.00	26.30	1000PCS
C4200HF207AKP6X005	25.20	30.50	1000PCS
C4200HF208AKP6X005	29.40	34.70	1000PCS
C4200HF209AKP6X005	33.60	38.90	1000PCS
C4200HF210AKP6X005	37.80	43.10	1000PCS
C4200HF211AKP6X005	42.00	47.30	1000PCS
C4200HF212AKP6X005	46.20	51.50	1000PCS

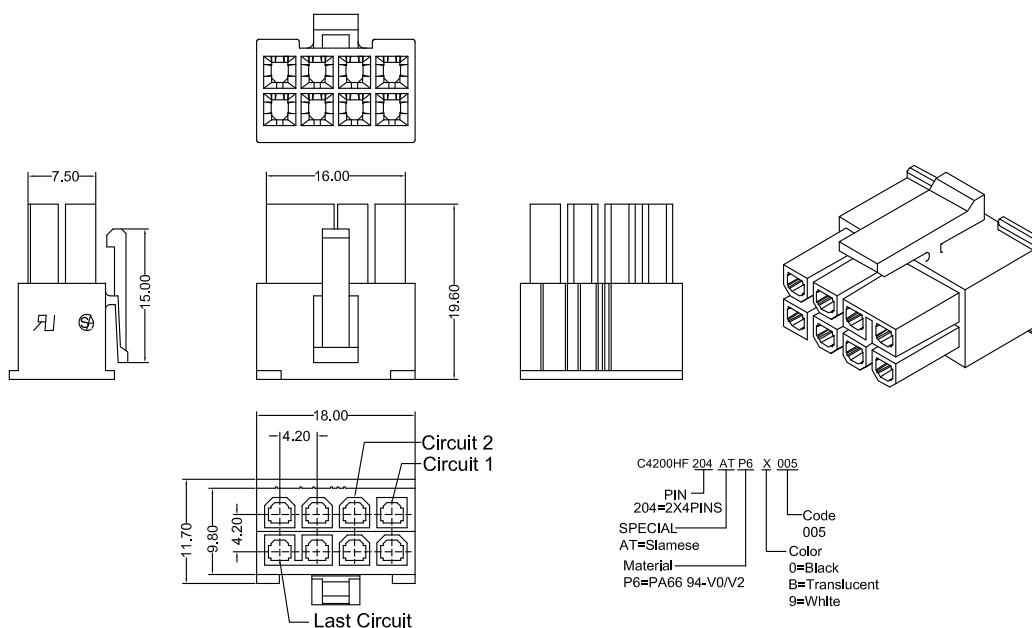

# C4200 MX 4.20

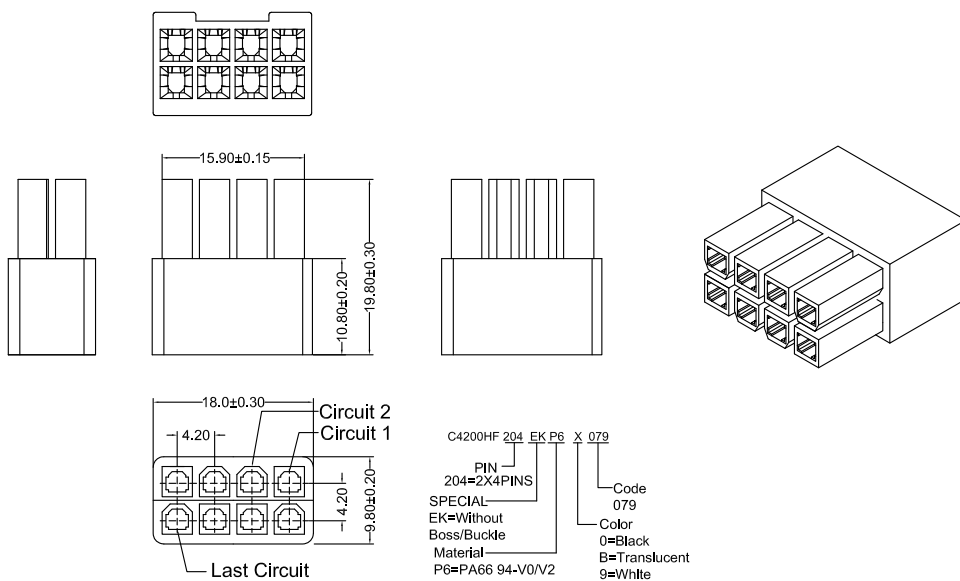
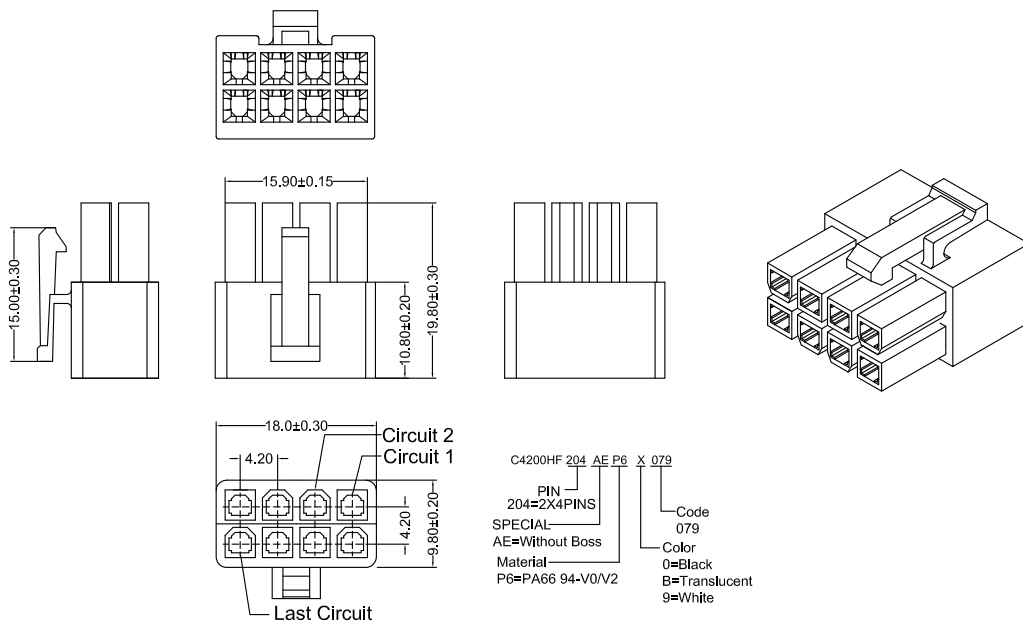



# C4200 MX 4.20

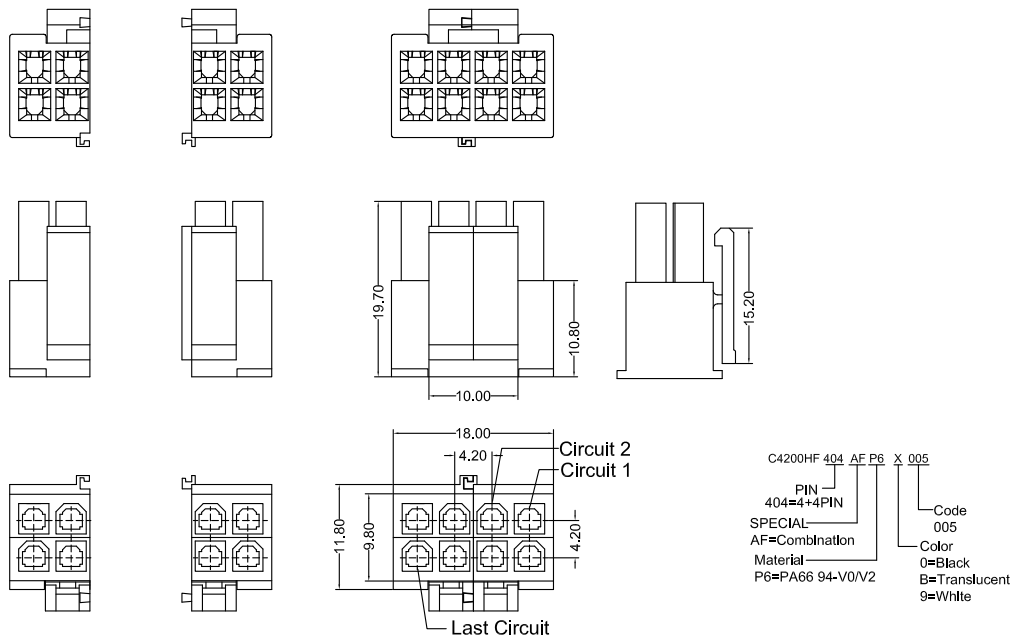
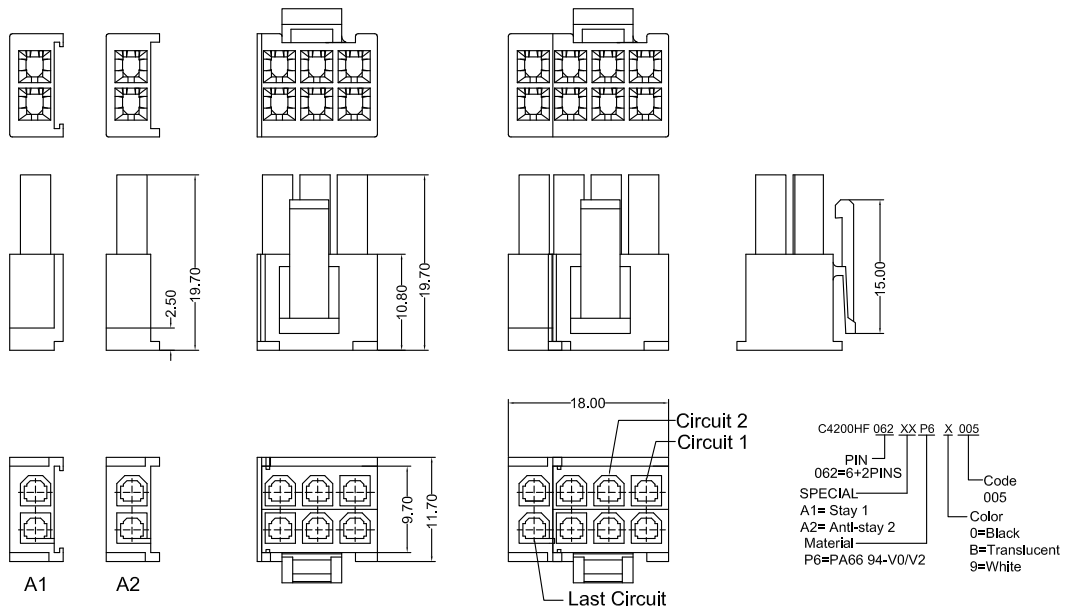

# C4200 MX 4.20

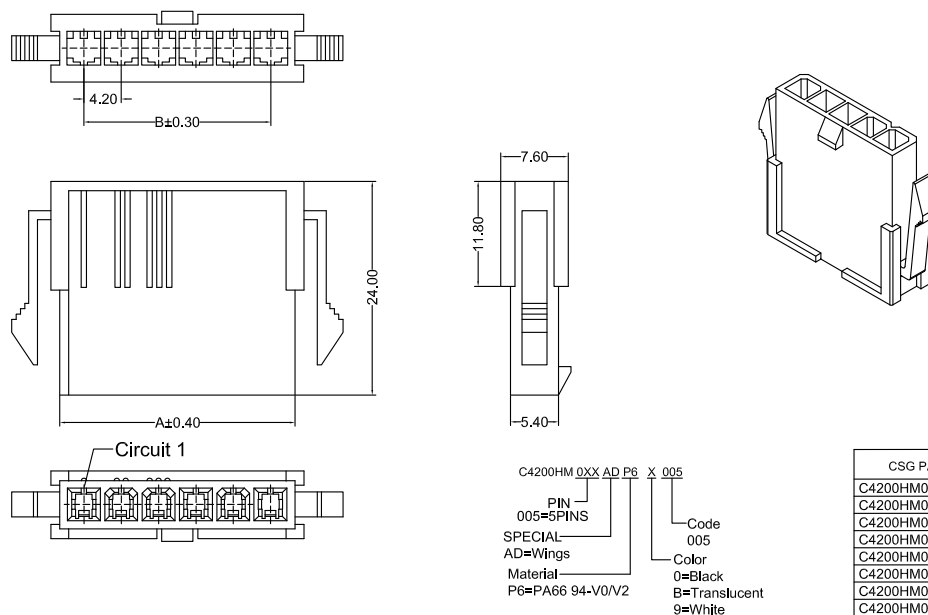
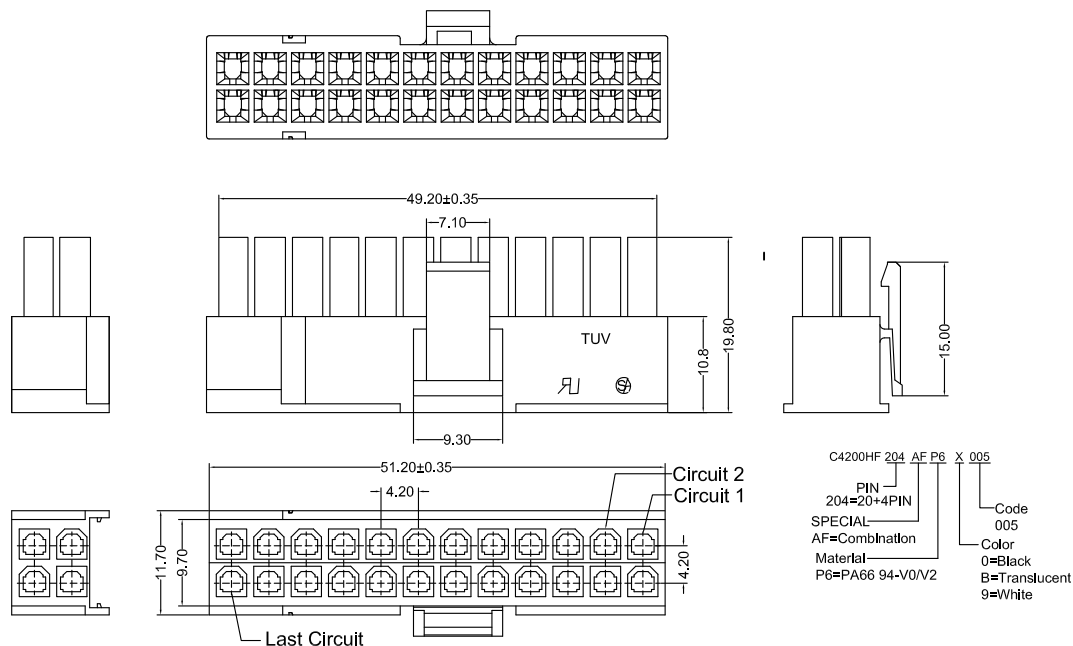

CSG PART NO.	Dimension mm		Q'ty/BAG
	A	B	
C4200HM002ADP6X005	4.20	9.60	1000PCS
C4200HM003ADP6X005	8.40	13.80	1000PCS
C4200HM004ADP6X005	12.60	18.00	1000PCS
C4200HM005ADP6X005	16.80	22.20	1000PCS
C4200HM006ADP6X005	21.00	26.40	1000PCS
C4200HM007ADP6X005	25.20	30.60	1000PCS
C4200HM008ADP6X005	29.40	34.80	1000PCS
C4200HM009ADP6X005	33.60	39.00	1000PCS
C4200HM010ADP6X005	37.80	43.20	1000PCS
C4200HM011ADP6X005	42.00	47.40	1000PCS
C4200HM012ADP6X005	46.20	51.60	1000PCS



# C4200 MX 4.20

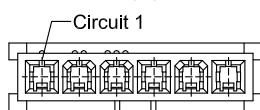
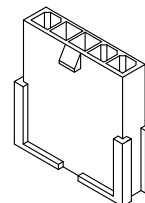
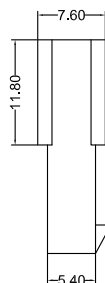
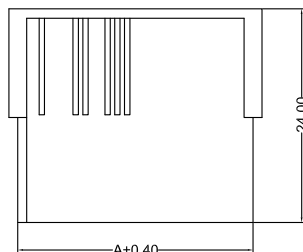
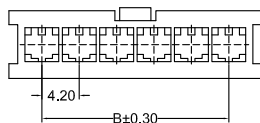

C4200HM 0XX AA P6 X 005

PIN  
005=5PINS

SPECIAL  
AA=NO Special

Material  
P6=PA66 94-V0/V2

Code  
005

Color  
0=Black  
B=Translucent  
9=White

CSG PART NO.	Dimension mm		Q'ty/BAG
	A	B	
C4200HM002AAP6X005	4.20	9.60	1000PCS
C4200HM003AAP6X005	8.40	13.80	1000PCS
C4200HM004AAP6X005	12.60	18.00	1000PCS
C4200HM005AAP6X005	16.80	22.20	1000PCS
C4200HM006AAP6X005	21.00	26.40	1000PCS
C4200HM007AAP6X005	25.20	30.60	1000PCS
C4200HM008AAP6X005	29.40	34.80	1000PCS
C4200HM009AAP6X005	33.60	39.00	1000PCS
C4200HM010AAP6X005	37.80	43.20	1000PCS
C4200HM011AAP6X005	42.00	47.40	1000PCS
C4200HM012AAP6X005	46.20	51.60	1000PCS

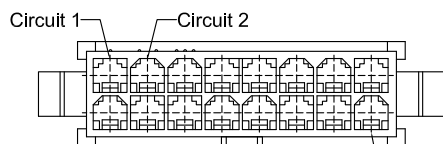
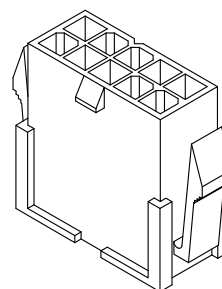
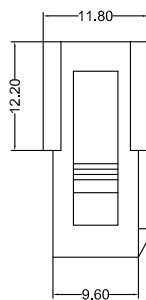
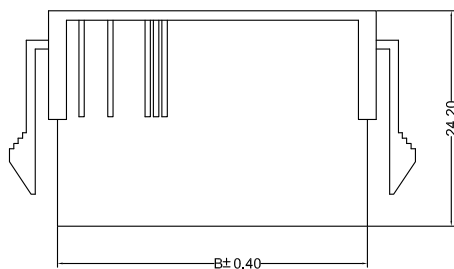
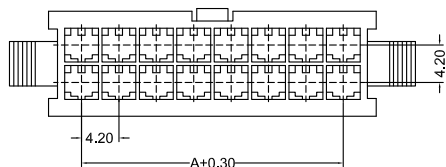

C4200HM 2XX AD P6 X 005

PIN  
205=2X5PINS

SPECIAL  
AD=Wings

Material  
P6=PA66 94-V0/V2

Code  
005

Color  
0=Black  
B=Translucent  
9=White

CSG PART NO.	Dimension mm		Q'ty/BAG
	A	B	
C4200HM201ADP6X005		5.40	1000PCS
C4200HM202ADP6X005	4.20	9.60	1000PCS
C4200HM203ADP6X005	8.40	13.80	1000PCS
C4200HM204ADP6X005	12.60	18.00	1000PCS
C4200HM205ADP6X005	16.80	22.20	1000PCS
C4200HM206ADP6X005	21.00	26.40	1000PCS
C4200HM207ADP6X005	25.20	30.60	1000PCS
C4200HM208ADP6X005	29.40	34.80	1000PCS
C4200HM209ADP6X005	33.60	39.00	1000PCS
C4200HM210ADP6X005	37.80	43.20	1000PCS
C4200HM211ADP6X005	42.00	47.40	1000PCS
C4200HM212ADP6X005	46.20	51.60	1000PCS



# C4200 MX 4.20

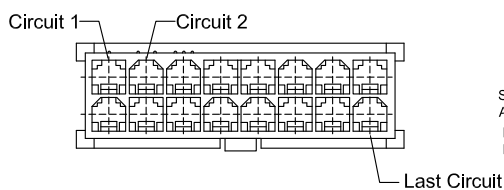
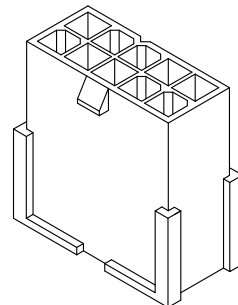
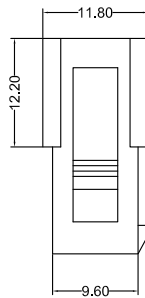
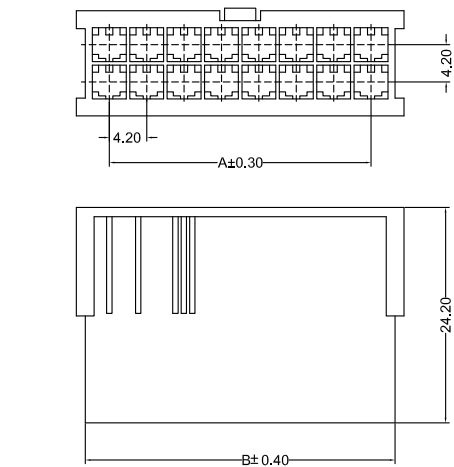

C4200HM 2XX AA P6 X 005  
 PIN 205=2X5PINS  
 SPECIAL  
 AA=NO Spectral  
 Material P6=PA66 94-V0/V2  
 Code 005  
 Color 0=Black  
 B=Translucent  
 9=White

CSG PART NO.	Dimension mm		Q'ty/BAG
	A	B	
C4200HM201AAP6X005	4.20	5.40	1000PCS
C4200HM202AAP6X005	4.20	9.60	1000PCS
C4200HM203AAP6X005	8.40	13.80	1000PCS
C4200HM204AAP6X005	12.60	18.00	1000PCS
C4200HM205AAP6X005	16.80	22.20	1000PCS
C4200HM206AAP6X005	21.00	26.40	1000PCS
C4200HM207AAP6X005	25.20	30.60	1000PCS
C4200HM208AAP6X005	29.40	34.80	1000PCS
C4200HM209AAP6X005	33.60	39.00	1000PCS
C4200HM210AAP6X005	37.80	43.20	1000PCS
C4200HM211AAP6X005	42.00	47.40	1000PCS
C4200HM212AAP6X005	46.20	51.60	1000PCS

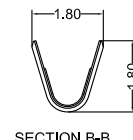
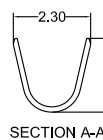
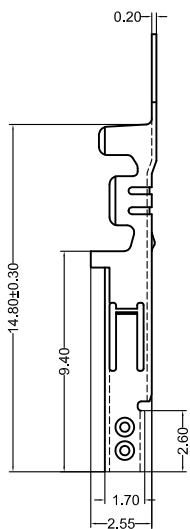
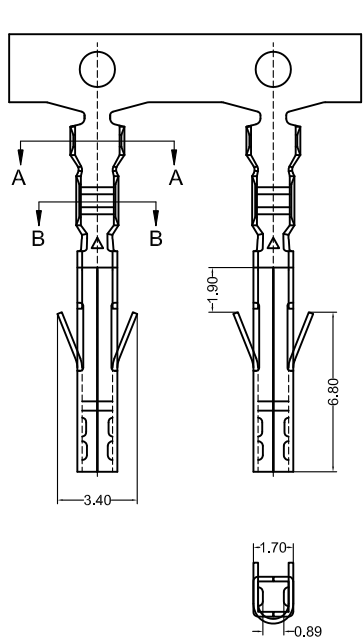

C4200 M J X XX 001  
 Type M=Female Terminal  
 SPECIAL J=Short  
 Material A=Phosphor Bronze  
 B=BRASS  
 H=C1100  
 Finish TP=Tin-Plated  
 GF=Gold-Plated  
 Code 001

CSG PART NO.	Wire Range	Insulation O.D.	Q'ty/Reel
C4200MJXTP001	AWG#20-#24	1.90mm(max)	10000PCS
C4200MJXGF001	AWG#20-#24	1.90mm(max)	10000PCS



# C4200 MX 4.20

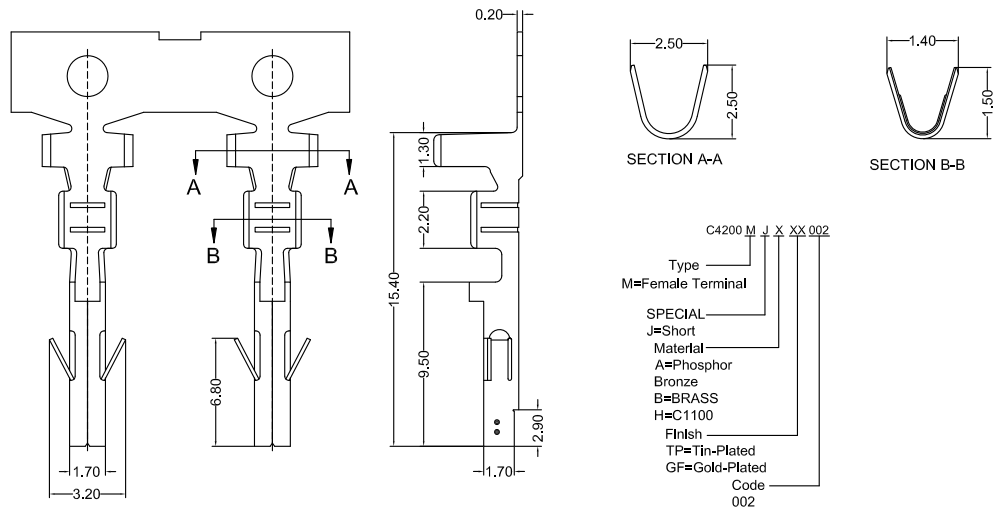

CSG PART NO.	Wire Range	Insulation O.D.	Q'ty/Reel
C4200MJTP002	AWG#20-#24	1.90mm(max)	10000PCS
C4200MJXF002	AWG#20-#24	1.90mm(max)	10000PCS

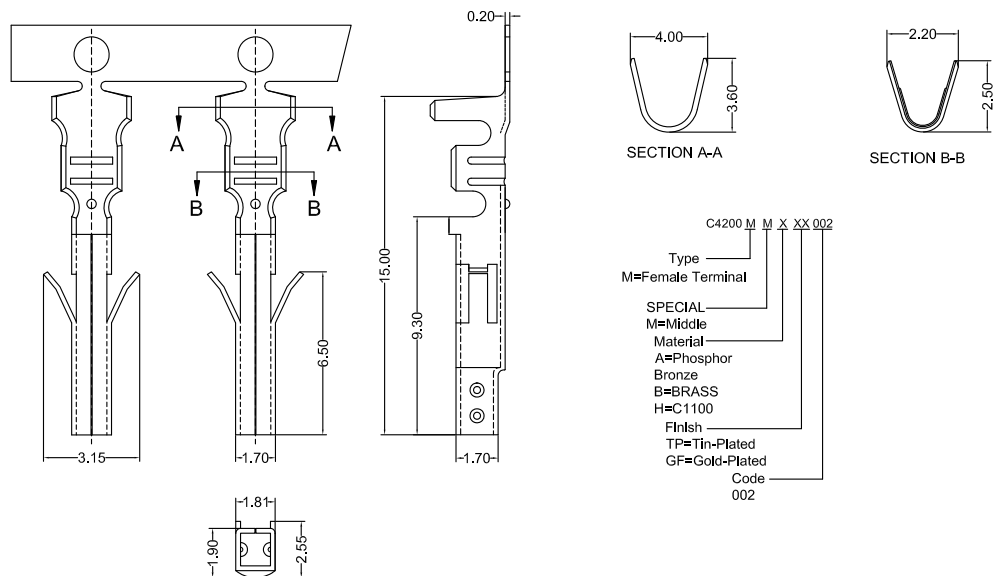

CSG PART NO.	Wire Range	Insulation O.D.	Q'ty/Reel
C4200MMXTP002	AWG#18-#24	3.10mm(max)	6000PCS
C4200MMXGF002	AWG#18-#24	3.10mm(max)	6000PCS



# C4200 MX 4.20

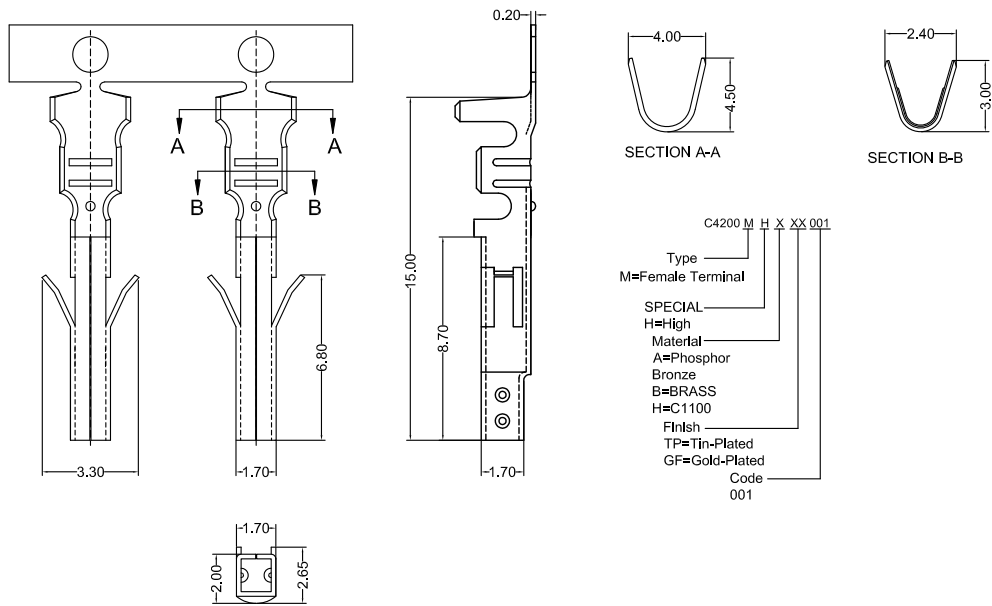

CSG PART NO.	Wire Range	Insulation O.D.	Q'ty/Reel
C4200MHXTP001	AWG#16-#24	4.30mm(max)	5000PCS
C4200MHXGF001	AWG#16-#24	4.30mm(max)	5000PCS

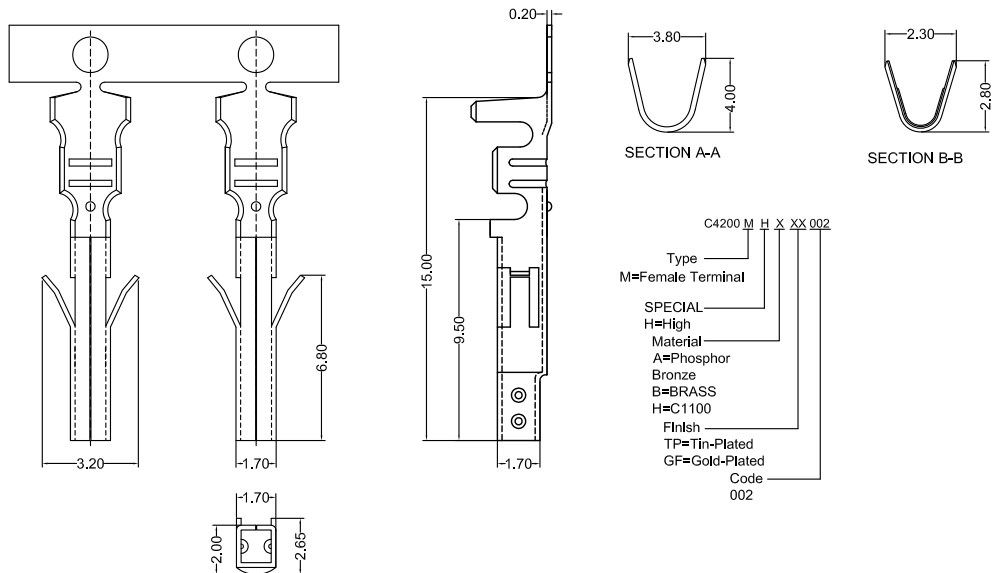

CSG PART NO.	Wire Range	Insulation O.D.	Q'ty/Reel
C4200MHXTP002	AWG#16-#24	4.30mm(max)	5000PCS
C4200MHXGF002	AWG#16-#24	4.30mm(max)	5000PCS



# C4200 MX 4.20

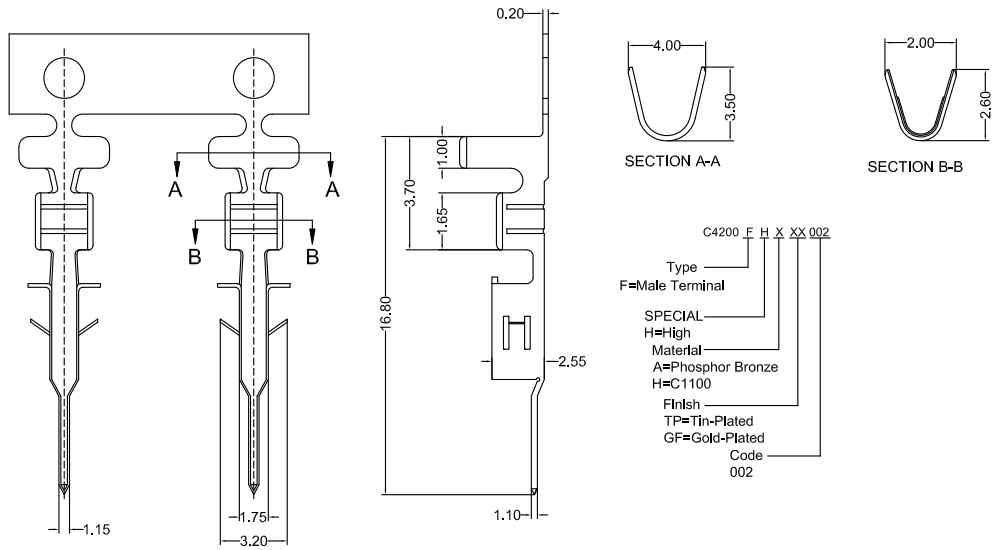

CSG PART NO.	Wire Range	Insulation O.D.	Q'ty/Reel
C4200FHXTPO02	AWG#18-#24	3.10mm(max)	5000PCS
C4200FHXGF002	AWG#18-#24	3.10mm(max)	5000PCS

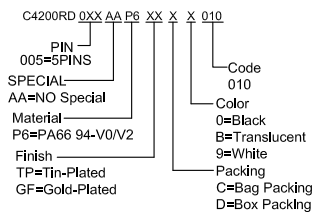
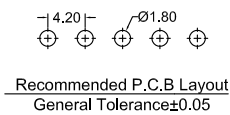
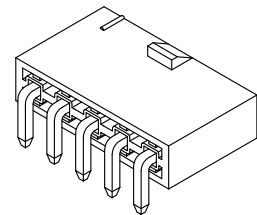
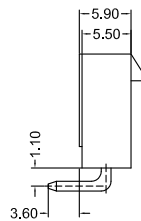
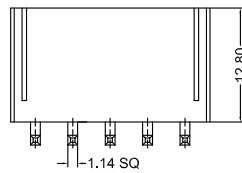
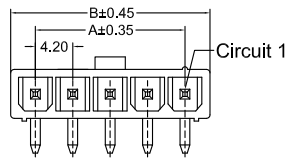

CSG PART NO.	Dimension mm		Q'ty
	A	B	
C4200RD002AAP6XXX010	4.20	9.60	1000PCS
C4200RD003AAP6XXX010	8.40	13.80	1000PCS
C4200RD004AAP6XXX010	12.60	18.00	1000PCS
C4200RD005AAP6XXX010	16.80	22.20	1000PCS
C4200RD006AAP6XXX010	21.00	26.40	1000PCS
C4200RD007AAP6XXX010	25.20	30.60	1000PCS
C4200RD008AAP6XXX010	29.40	34.80	1000PCS
C4200RD009AAP6XXX010	33.60	39.00	1000PCS
C4200RD010AAP6XXX010	37.80	43.20	1000PCS
C4200RD011AAP6XXX010	42.00	47.40	1000PCS
C4200RD012AAP6XXX010	46.20	51.60	1000PCS



# C4200 MX 4.20

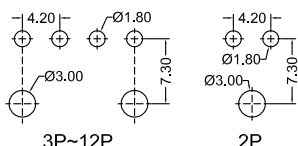
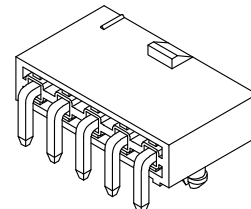
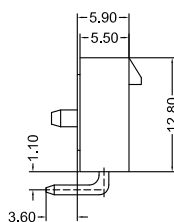
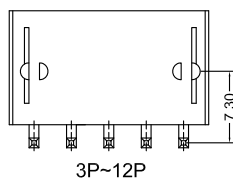
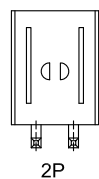
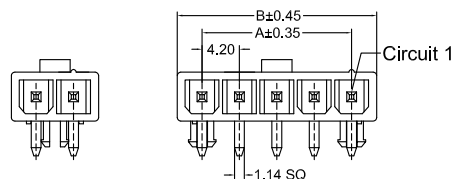

Recommended P.C.B Layout  
General Tolerance±0.05

C4200RD 0XX AP P6 XX X X 010

- PIN 005=5PINS
- SPECIAL
- AP=Pillars
- Material P6=PA66 94-V0/V2
- Finish TP=Tin-Plated GF=Gold-Plated
- Code 010
- Color 0=Black B=Translucent 9=White
- Packing C=Bag Packing D=Box Packing

CSG PART NO.	Dimension mm		Q'ty
	A	B	
C4200RD002APP6XXX010	4.20	9.60	1000PCS
C4200RD003APP6XXX010	8.40	13.80	1000PCS
C4200RD004APP6XXX010	12.60	18.00	1000PCS
C4200RD005APP6XXX010	16.80	22.20	1000PCS
C4200RD006APP6XXX010	21.00	26.40	1000PCS
C4200RD007APP6XXX010	25.20	30.60	1000PCS
C4200RD008APP6XXX010	29.40	34.80	1000PCS
C4200RD009APP6XXX010	33.60	39.00	1000PCS
C4200RD010APP6XXX010	37.80	43.20	1000PCS
C4200RD011APP6XXX010	42.00	47.40	1000PCS
C4200RD012APP6XXX010	46.20	51.60	1000PCS

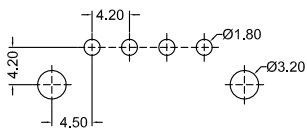
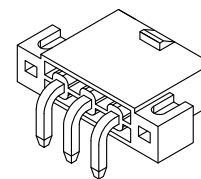
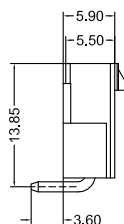
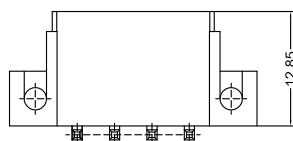
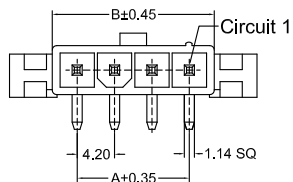

Recommended P.C.B Layout  
General Tolerance±0.05

C4200RD 0XX AS P6 XX X X 010

- PIN 005=5PINS
- SPECIAL
- AS=Screw Hole
- Material P6=PA66 94-V0/V2
- Finish TP=Tin-Plated GF=Gold-Plated
- Code 010
- Color 0=Black B=Translucent 9=White
- Packing C=Bag Packing D=Box Packing

CSG PART NO.	Dimension mm		Q'ty
	A	B	
C4200RD002ASP6XXX010	4.20	9.80	1000PCS
C4200RD003ASP6XXX010	8.40	14.00	1000PCS
C4200RD004ASP6XXX010	12.60	18.20	1000PCS
C4200RD005ASP6XXX010	16.80	22.40	1000PCS
C4200RD006ASP6XXX010	21.00	26.60	1000PCS
C4200RD007ASP6XXX010	25.20	30.80	1000PCS
C4200RD008ASP6XXX010	29.40	35.00	1000PCS
C4200RD009ASP6XXX010	33.60	39.20	1000PCS
C4200RD010ASP6XXX010	37.80	43.40	1000PCS
C4200RD011ASP6XXX010	42.00	47.60	1000PCS
C4200RD012ASP6XXX010	46.20	51.80	1000PCS





# C4200 MX 4.20

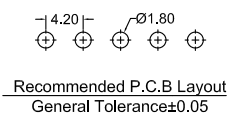
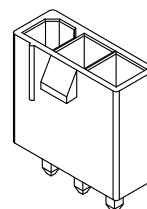
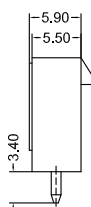
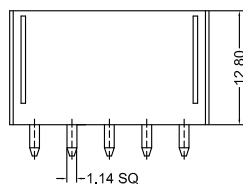
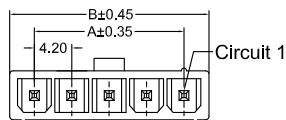

C4200VD 0XX AA P6 XX C X 010

- PIN
- 005=5PINS
- SPECIAL
- AA=NO Special
- Material
- P6=PA66 94-V0/V2
- Finish
- TP=Tin-Plated
- GF=Gold-Plated
- Code
- 010
- Color
- 0=Black
- B=Translucent
- 9=White
- Packing
- C=Bag Packing

CSG PART NO.	Dimension mm		Q'ty
	A	B	
C4200VD002AAP6XXCX010	4.20	9.60	1000PCS
C4200VD003AAP6XXCX010	8.40	13.80	1000PCS
C4200VD004AAP6XXCX010	12.60	18.00	1000PCS
C4200VD005AAP6XXCX010	16.80	22.20	1000PCS
C4200VD006AAP6XXCX010	21.00	26.40	1000PCS
C4200VD007AAP6XXCX010	25.20	30.60	1000PCS
C4200VD008AAP6XXCX010	29.40	34.80	1000PCS
C4200VD009AAP6XXCX010	33.60	39.00	1000PCS
C4200VD010AAP6XXCX010	37.80	43.20	1000PCS
C4200VD011AAP6XXCX010	42.00	47.40	1000PCS
C4200VD012AAP6XXCX010	46.20	51.60	1000PCS

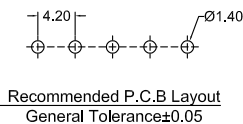
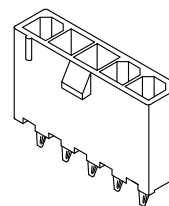
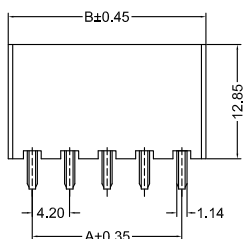
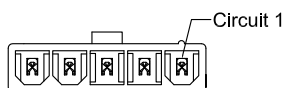

C4200VD 0XX AI P6 XX X X 010

- PIN
- 005=5PINS
- SPECIAL
- AI=Tubular PIN
- Material
- P6=PA66 94-V0/V2
- Finish
- TP=Tin-Plated
- GF=Gold-Plated
- Code
- 010
- Color
- 0=Black
- B=Translucent
- 9=White
- Packing
- C=Bag Packing
- A=Tube Packing

CSG PART NO.	Dimension mm		Q'ty
	A	B	
C4200RD002AIP6XXX010	4.20	9.60	1000PCS
C4200RD003AIP6XXX010	8.40	13.80	1000PCS
C4200RD004AIP6XXX010	12.60	18.00	1000PCS
C4200RD005AIP6XXX010	16.80	22.20	1000PCS
C4200RD006AIP6XXX010	21.00	26.40	1000PCS
C4200RD007AIP6XXX010	25.20	30.60	1000PCS
C4200RD008AIP6XXX010	29.40	34.80	1000PCS
C4200RD009AIP6XXX010	33.60	39.00	1000PCS
C4200RD010AIP6XXX010	37.80	43.20	1000PCS
C4200RD011AIP6XXX010	42.00	47.40	1000PCS
C4200RD012AIP6XXX010	46.20	51.60	1000PCS



# C4200 MX 4.20

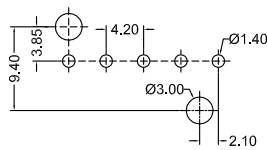
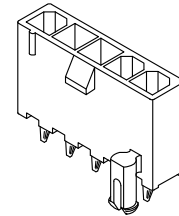
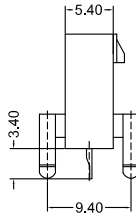
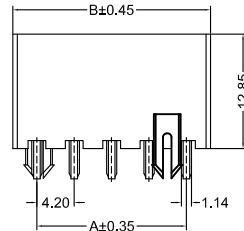
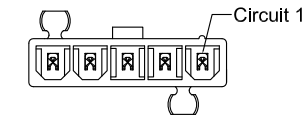

Recommended P.C.B Layout  
General Tolerance±0.05

C4200VD 0XX IP P6 XX C X 010  
 PIN 005=5PINS  
 SPECIAL IP=Tubular Pillars  
 Material P6=PA66 94-V0/V2  
 Finish TP=Tin-Plated GF=Gold-Plated  
 Code 010  
 Color 0=Black B=Translucent 9=White  
 Packing C=Bag Packing

CSG PART NO.	Dimension mm		Q'ty
	A	B	
C4200VD003IPP6XXCX010	8.40	13.80	1000PCS
C4200VD004IPP6XXCX010	12.60	18.00	1000PCS
C4200VD005IPP6XXCX010	16.80	22.20	1000PCS
C4200VD006IPP6XXCX010	21.00	26.40	1000PCS
C4200VD007IPP6XXCX010	25.20	30.60	1000PCS
C4200VD008IPP6XXCX010	29.40	34.80	1000PCS
C4200VD009IPP6XXCX010	33.60	39.00	1000PCS
C4200VD010IPP6XXCX010	37.80	43.20	1000PCS
C4200VD011IPP6XXCX010	42.00	47.40	1000PCS
C4200VD012IPP6XXCX010	46.20	51.60	1000PCS

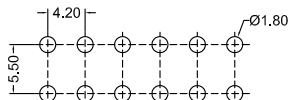
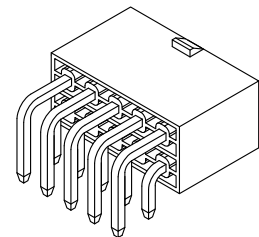
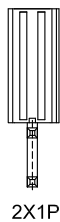
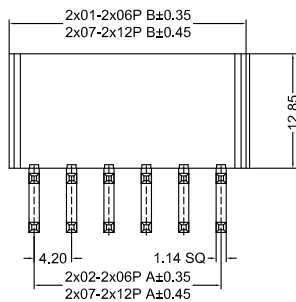
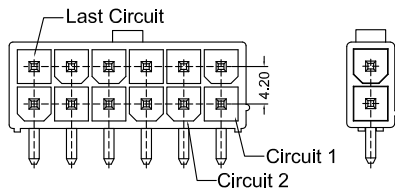

Recommended P.C.B Layout  
General Tolerance±0.05

C4200RD 2XX AA XX XX X X 010  
 PIN 205=2X5PINS  
 SPECIAL AA=NO Special  
 Material P6=PA66 94-V0/V2 9T=PA9T 94-V0  
 Finish TP=Tin-Plated GF=Gold-Plated  
 Code 010  
 Color 0=Black B=Translucent 9=White  
 Packing C=Bag Packing D=Box Packing

CSG PART NO.	Dimension mm		Q'ty
	A	B	
C4200RD201AAXXXXXX010	5.60	10.00	1000PCS
C4200RD202AAXXXXXX010	4.20	9.80	1000PCS
C4200RD203AAXXXXXX010	8.40	14.00	1000PCS
C4200RD204AAXXXXXX010	12.60	18.20	1000PCS
C4200RD205AAXXXXXX010	16.80	22.40	1000PCS
C4200RD206AAXXXXXX010	21.00	26.60	1000PCS
C4200RD207AAXXXXXX010	25.20	30.80	1000PCS
C4200RD208AAXXXXXX010	29.40	35.00	1000PCS
C4200RD209AAXXXXXX010	33.60	39.20	1000PCS
C4200RD210AAXXXXXX010	37.80	43.40	1000PCS
C4200RD211AAXXXXXX010	42.00	47.60	1000PCS
C4200RD212AAXXXXXX010	46.20	51.80	1000PCS



# C4200 MX 4.20

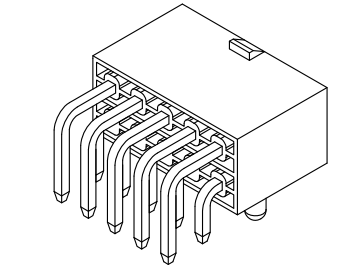
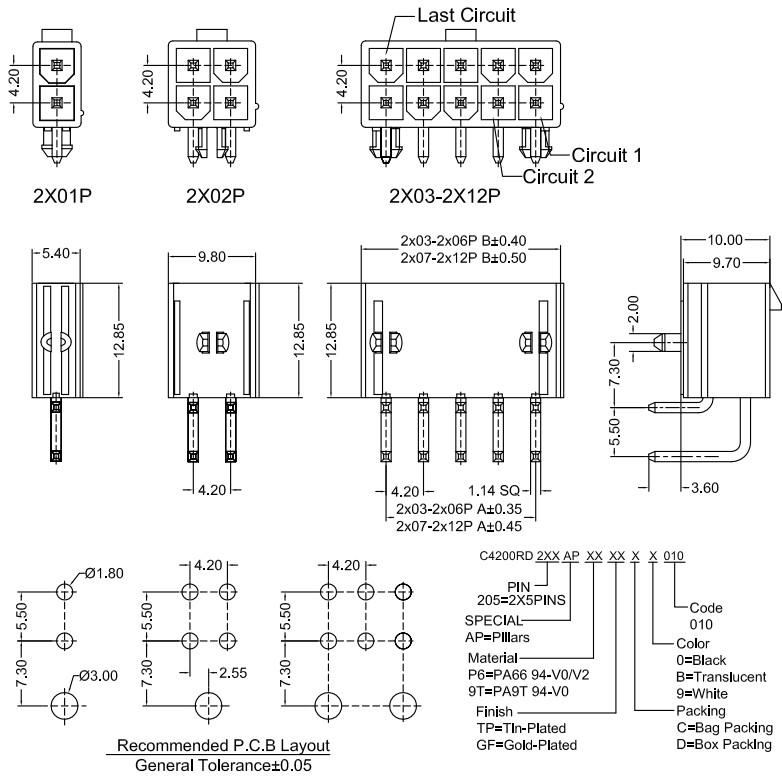

CSG PART NO.	Dimension mm		Q'ty
	A	B	
C4200RD201APXXXXXX010	5.40	1000PCS	
C4200RD202APXXXXXX010	4.20 9.80	1000PCS	
C4200RD203APXXXXXX010	8.40 14.00	1000PCS	
C4200RD204APXXXXXX010	12.60 18.20	1000PCS	
C4200RD205APXXXXXX010	16.80 22.40	1000PCS	
C4200RD206APXXXXXX010	21.00 26.60	1000PCS	
C4200RD207APXXXXXX010	25.20 30.80	1000PCS	
C4200RD208APXXXXXX010	29.40 35.00	1000PCS	
C4200RD209APXXXXXX010	33.60 39.20	1000PCS	
C4200RD210APXXXXXX010	37.80 43.40	1000PCS	
C4200RD211APXXXXXX010	42.00 47.60	1000PCS	
C4200RD212APXXXXXX010	46.20 51.80	1000PCS	

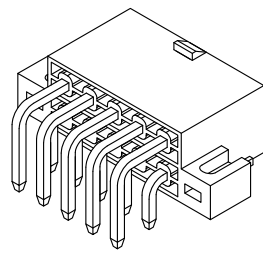
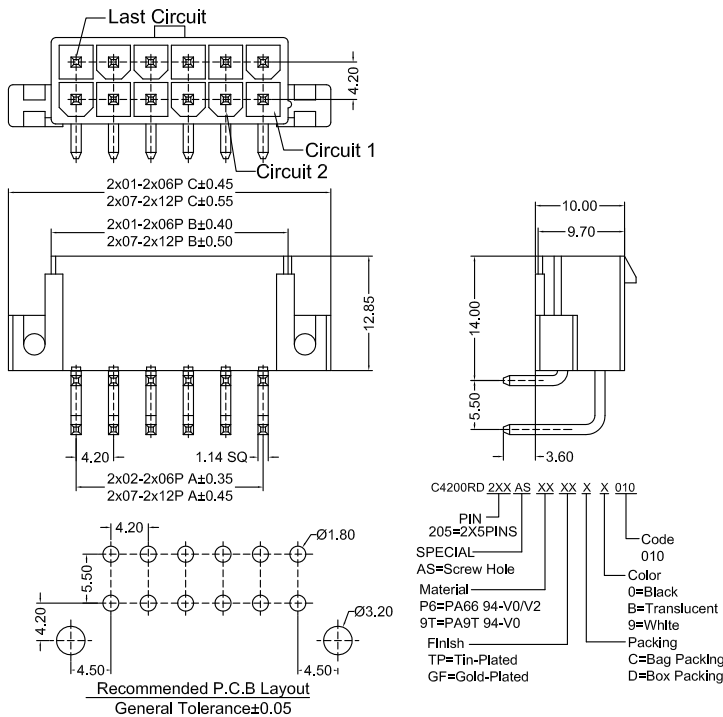

CSG PART NO.	Dimension mm			Q'ty
	A	B	C	
C4200RD201ASXXXXXX010	5.60	15.20	1000PCS	
C4200RD202ASXXXXXX010	4.20 9.80	19.40	1000PCS	
C4200RD203ASXXXXXX010	8.40 14.00	23.60	1000PCS	
C4200RD204ASXXXXXX010	12.60 18.20	27.80	1000PCS	
C4200RD205ASXXXXXX010	16.80 22.40	32.00	1000PCS	
C4200RD206ASXXXXXX010	21.00 26.60	36.20	1000PCS	
C4200RD207ASXXXXXX010	25.20 30.80	40.40	1000PCS	
C4200RD208ASXXXXXX010	29.40 35.00	44.60	1000PCS	
C4200RD209ASXXXXXX010	33.60 39.20	48.80	1000PCS	
C4200RD210ASXXXXXX010	37.80 43.40	53.00	1000PCS	
C4200RD211ASXXXXXX010	42.00 47.60	57.20	1000PCS	
C4200RD212ASXXXXXX010	46.20 51.80	61.40	1000PCS	



# C4200 MX 4.20

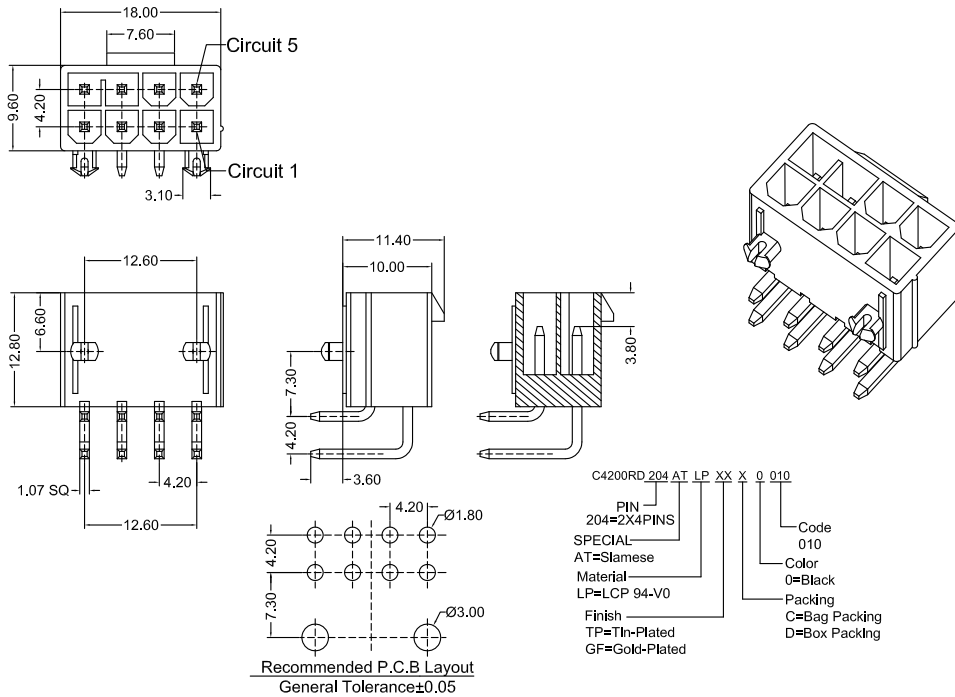
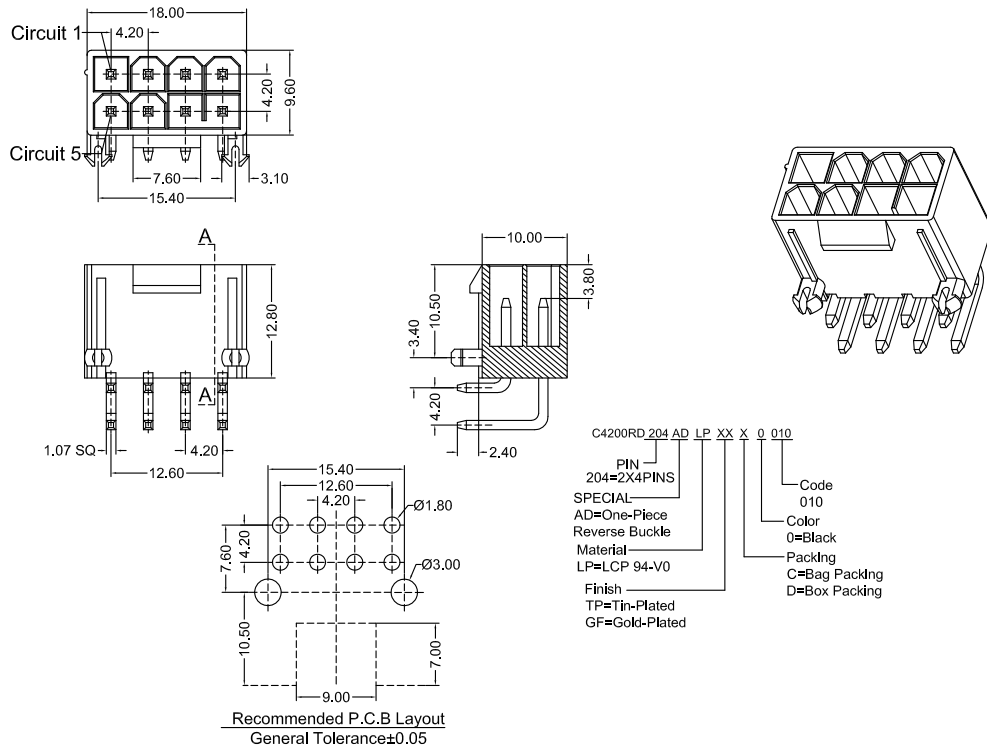

# C4200 MX 4.20

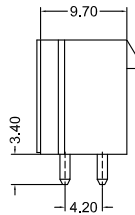
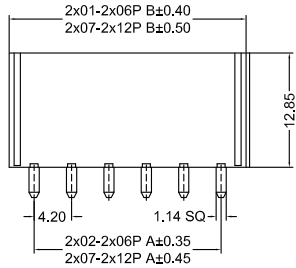
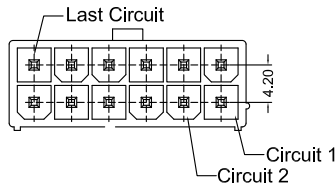

2X12P High temperature material

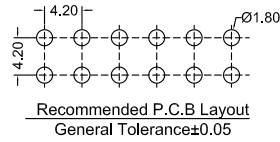
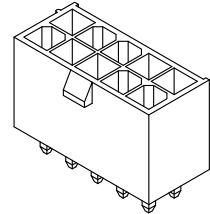

Recommended P.C.B Layout  
General Tolerance±0.05

C4200VD 2XX AX XX XX X 010  
 PIN 205=2X5PINS  
 SPECIAL AA=NO Spectral AT=Siamese  
 Material P6=PA66 94-V0/V2 9T=PA9T 94-V0  
 Finish TP=Tin-Plated GF=Gold-Plated  
 Code 010  
 Color 0=Black B=Translucent 9=White  
 Packing C=Bag Packing

CSG PART NO.	Dimension mm		Q'ty
	A	B	
C4200VD201AAXXXXCX010	5.60	9.80	1000PCS
C4200VD202AAXXXXCX010	4.20	9.80	1000PCS
C4200VD203AAXXXXCX010	8.40	14.00	1000PCS
C4200VD204AAXXXXCX010	12.60	18.20	1000PCS
C4200VD205AAXXXXCX010	16.80	22.40	1000PCS
C4200VD206AAXXXXCX010	21.00	26.60	1000PCS
C4200VD207AAXXXXCX010	25.20	30.80	1000PCS
C4200VD208AAXXXXCX010	29.40	35.00	1000PCS
C4200VD209AAXXXXCX010	33.60	39.20	1000PCS
C4200VD210AAXXXXCX010	37.80	43.40	1000PCS
C4200VD211AAXXXXCX010	42.00	47.60	1000PCS
C4200VD212AAXXXXCX010	46.20	51.80	1000PCS

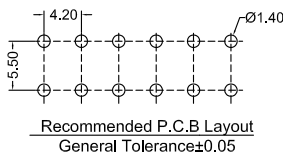
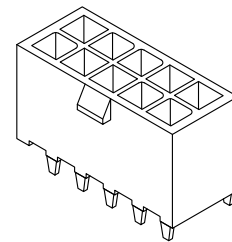
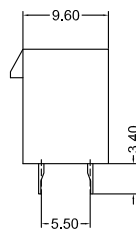
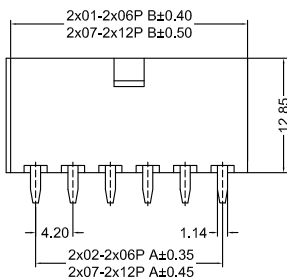
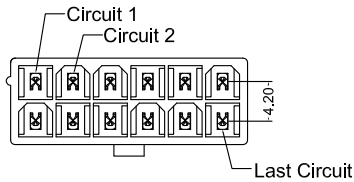

Recommended P.C.B Layout  
General Tolerance±0.05

C4200VD 2XX AI XX XX X 010  
 PIN 205=2X5PINS  
 SPECIAL AI=Tubular PIN  
 Material P6=PA66 94-V0/V2 9T=PA9T 94-V0  
 Finish TP=Tin-Plated GF=Gold-Plated  
 Code 010  
 Color 0=Black B=Translucent 9=White  
 Packing C=Bag Packing D=Box Packing A=Tube Packing B=Reel Packing

CSG PART NO.	Dimension mm		Q'ty
	A	B	
C4200VD201AIXXXXXX010	5.60	9.80	1000PCS
C4200VD202AIXXXXXX010	4.20	9.80	1000PCS
C4200VD203AIXXXXXX010	8.40	14.00	1000PCS
C4200VD204AIXXXXXX010	12.60	18.20	1000PCS
C4200VD205AIXXXXXX010	16.80	22.40	1000PCS
C4200VD206AIXXXXXX010	21.00	26.60	1000PCS
C4200VD207AIXXXXXX010	25.20	30.80	1000PCS
C4200VD208AIXXXXXX010	29.40	35.00	1000PCS
C4200VD209AIXXXXXX010	33.60	39.20	1000PCS
C4200VD210AIXXXXXX010	37.80	43.40	1000PCS
C4200VD211AIXXXXXX010	42.00	47.60	1000PCS
C4200VD212AIXXXXXX010	46.20	51.80	1000PCS



# C4200 MX 4.20

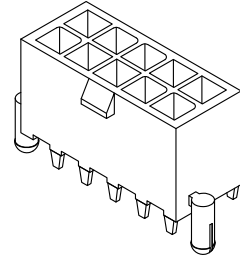
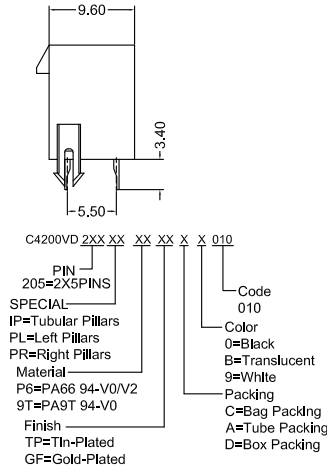
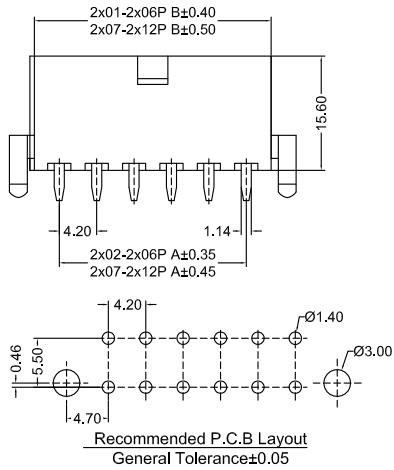
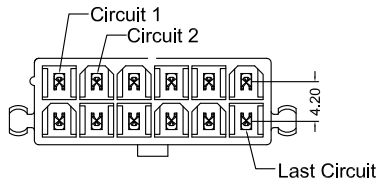

CSG PART NO.	Dimension mm		Q'ty
	A	B	
C4200VD201XXXXXXXXX010	5.60	9.80	1000PCS
C4200VD202XXXXXXXXX010	4.20	9.80	1000PCS
C4200VD203XXXXXXXXX010	8.40	14.00	1000PCS
C4200VD204XXXXXXXXX010	12.60	18.20	1000PCS
C4200VD205XXXXXXXXX010	16.80	22.40	1000PCS
C4200VD206XXXXXXXXX010	21.00	26.60	1000PCS
C4200VD207XXXXXXXXX010	25.20	30.80	1000PCS
C4200VD208XXXXXXXXX010	29.40	35.00	1000PCS
C4200VD209XXXXXXXXX010	33.60	39.20	1000PCS
C4200VD210XXXXXXXXX010	37.80	43.40	1000PCS
C4200VD211XXXXXXXXX010	42.00	47.60	1000PCS
C4200VD212XXXXXXXXX010	46.20	51.80	1000PCS

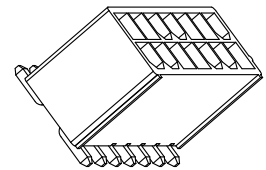
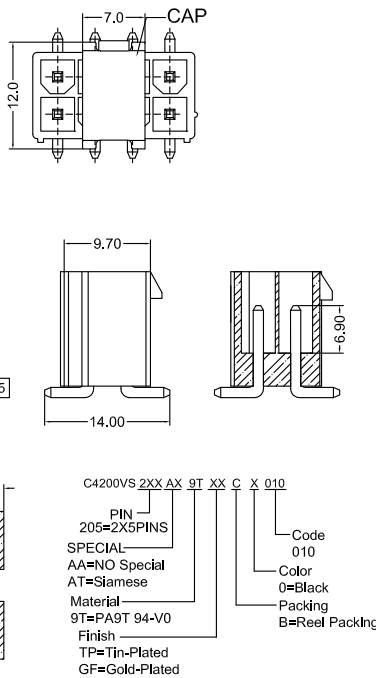
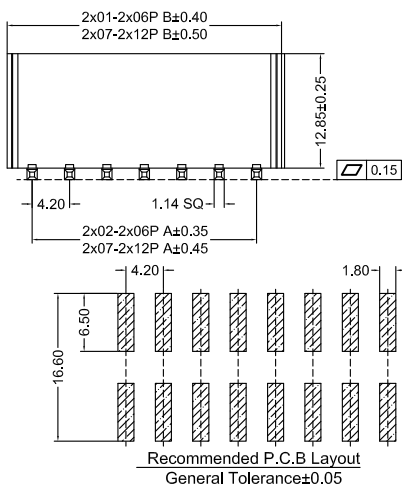
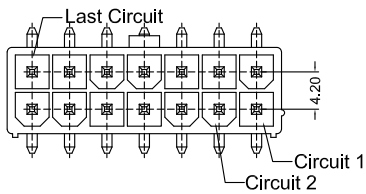

CSG PART NO.	Dimension mm		Q'ty
	A	B	
C4200VS201AA9TXXB0010	5.60	9.80	1000PCS
C4200VS202AA9TXXB0010	4.20	9.80	1000PCS
C4200VS203AA9TXXB0010	8.40	14.00	1000PCS
C4200VS204AA9TXXB0010	12.60	18.20	1000PCS
C4200VS205AA9TXXB0010	16.80	22.40	1000PCS
C4200VS206AA9TXXB0010	21.00	26.60	1000PCS
C4200VS207AA9TXXB0010	25.20	30.80	1000PCS
C4200VS208AA9TXXB0010	29.40	35.00	1000PCS
C4200VS209AA9TXXB0010	33.60	39.20	1000PCS
C4200VS210AA9TXXB0010	37.80	43.40	1000PCS
C4200VS211AA9TXXB0010	42.00	47.60	1000PCS
C4200VS212AA9TXXB0010	46.20	51.80	1000PCS

