

A1505 CZH CONNECTOR

1.50mm Pitch/Disconnectable Crimp style connectors

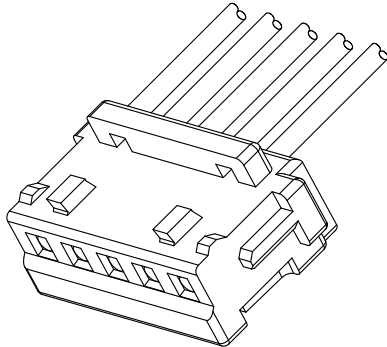

 E529482

- Secure locking structure
- Low insertion force
- Suction area for picking up
- Improvement of engagement with prying

Specifications: _____

- Current rating: 2.0 A / AC,DC
- Voltage rating: 100 V AC/DC
- Temperature range: -40°C~+105°C
(including temperature rise in applying electrical current)
- Contact resistance: Initial value/ 30mΩ max
Insulation resistance: 500 MΩ min
Withstanding voltage: 500 VAC/minute
Applicable wire: Conductor size/ AWG#26~#32
Insulation O.D./ 0.50 to 1.05 mm
- * Compliant with RoHS2/ REACH
- * Refer to "General Instruction and Notice when using Terminals and Connectors"
- * Contact CSG for details

Material: _____

Housing: PA66/UL94-V0;Color:White

Terminal: Phosphor/ Tin-plated/ Gold-Plated

- Note: 1. The above figure is the figure viewed from the connector mounting side.
2. Tolerances are non-cumulative: ± 0.08 mm for all centers.
3. The dimensions above should serve as a guideline. Contact CSG for details.

CSG

A1505 CZH

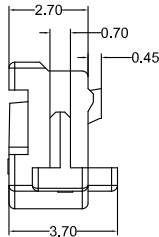
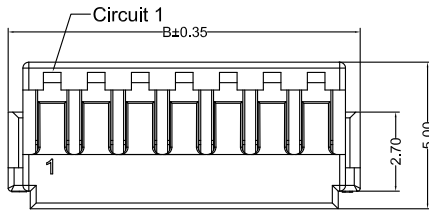
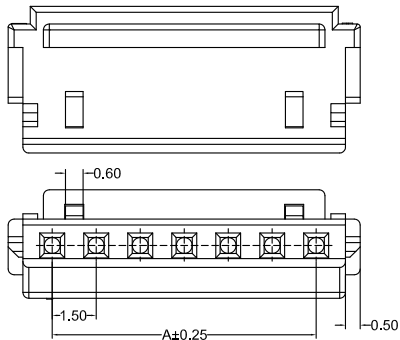

A1505HF 0XX AA P6 9 079

005=5PINS
SPECIAL
AA=NO Special
Material
P6=PA66 94V-0

Code
079
Color
9=White

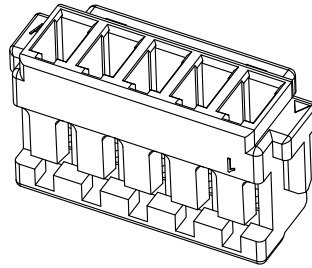

CSG PART NO.	Dimension mm		Q'ty/BAG
	A	B	
A1505HF002AAP69079	1.50	4.50	1000PCS
A1505HF003AAP69079	3.00	6.00	1000PCS
A1505HF004AAP69079	4.50	7.50	1000PCS
A1505HF005AAP69079	6.00	9.00	1000PCS
A1505HF006AAP69079	7.50	10.50	1000PCS
A1505HF007AAP69079	9.00	12.00	1000PCS
A1505HF008AAP69079	10.50	13.50	1000PCS
A1505HF009AAP69079	12.00	15.00	1000PCS
A1505HF010AAP69079	13.50	16.50	1000PCS
A1505HF011AAP69079	15.00	18.00	1000PCS
A1505HF012AAP69079	16.50	19.50	1000PCS
A1505HF013AAP69079	18.00	21.00	1000PCS
A1505HF014AAP69079	19.50	22.50	1000PCS
A1505HF015AAP69079	21.00	24.00	1000PCS
A1505HF016AAP69079	22.50	25.50	1000PCS
A1505HF017AAP69079	24.00	27.00	1000PCS
A1505HF018AAP69079	25.50	28.50	1000PCS
A1505HF019AAP69079	27.00	30.00	1000PCS
A1505HF020AAP69079	28.50	31.50	1000PCS

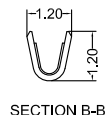
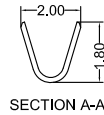
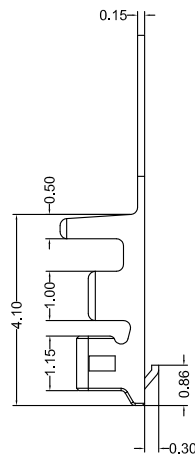
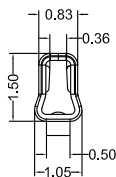
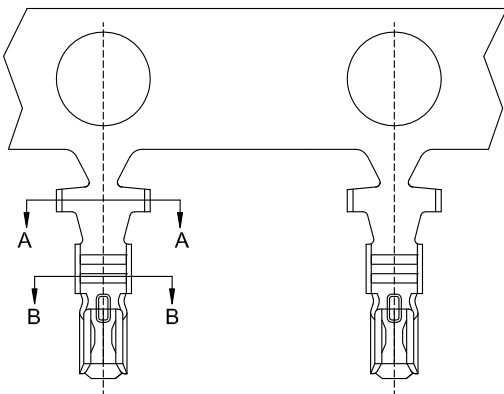

A1505 M 0 A XX 010

Type
M=Female Terminal
SPECIAL
0=NO Special
Material
A=Phosphor
Finish
TP=Tin-Plated
GF=Gold-Plated/GF
Code
010

CSG PART NO.	Wire Range	Insulation O.D.	Q'ty/Reel
A1505M0ATP010	AWG#26-#32	1.05mm(max)	10000PCS
A1505M0AGF010	AWG#26-#32	1.05mm(max)	10000PCS

CSG