

A3961 VH 3.96 CONNECTOR

3.96mm Pitch/Disconnectable Crimp style connectors

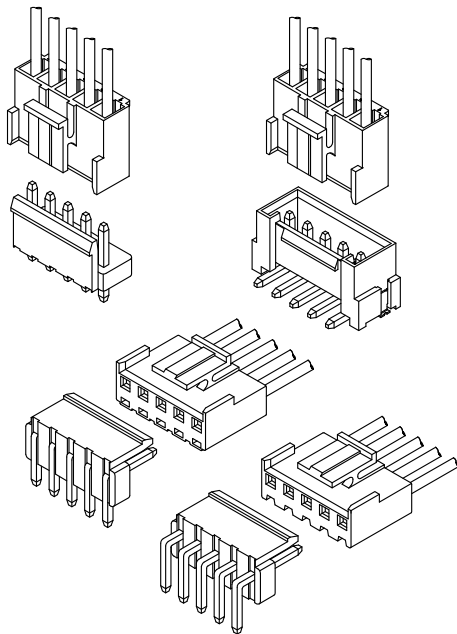

- Secure locking structure
- Low insertion force
- Suction area for picking up
- Improvement of engagement with prying

Specifications:

- Current rating: 7.0 A / AC,DC (AWG #18)
- Voltage rating: 250 V AC/DC
- Temperature range: -25°C ~ +105°C
(including temperature rise in applying electrical current)
- Contact resistance: Initial value/ 20m Ω max
Insulation resistance: 1000 M Ω min
Withstanding voltage: 1500 VAC/minute
Applicable wire: Conductor size/ AWG#22~#16
Insulation O.D./ 1.50 to 3.00 mm

- * Compliant with RoHS2/ REACH
- * Refer to "General Instruction and Notice when using Terminals and Connectors"
- * Contact CSG for details

Material:

Housing: PA66/UL94-V0;Color:White
Terminal: Phosphor Tin-plated/ Gold-Plated
DIP Wafer Housing: PA66/ LCP,UL94-V0;Color:White/Gray
DIP Wafer Pin: Brass Tin-plated/ Gold-Plated
SMT Wafer Housing: PA9T,UL94-V0;Color:Natural
SMT Wafer Pin: Brass Tin-plated
SMT Wafer Fixed Foot: Brass/ Tin-plated

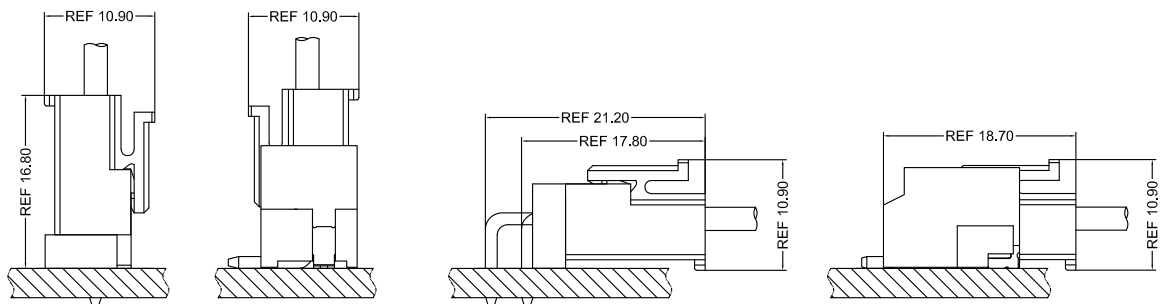

- Note: 1. The above figure is the figure viewed from the connector mounting side.
2. Tolerances are non-cumulative: ± 0.08 mm for all centers.
3. The dimensions above should serve as a guideline. Contact CSG for details.



A3961 VH 3.96

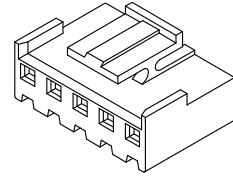
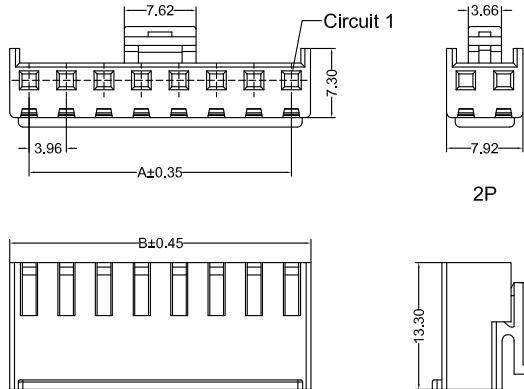

A3961HF 0XX AK P6 9 XXX

PIN
005=5PINS

SPECIAL
AK=BUCKLE

Material
P6=PA66 94V-0

Code
005
204

Color
9=White

CSG PART NO.	Dimension mm		Q'ty/BAG
	A	B	
A3961HF002AKP69XXX	3.96	7.92	1000PCS
A3961HF003AKP69XXX	7.92	11.88	1000PCS
A3961HF004AKP69XXX	11.88	15.84	1000PCS
A3961HF005AKP69XXX	15.84	19.80	1000PCS
A3961HF006AKP69XXX	19.80	23.76	1000PCS
A3961HF007AKP69XXX	23.76	27.72	1000PCS
A3961HF008AKP69XXX	27.72	31.68	1000PCS
A3961HF009AKP69XXX	31.68	35.64	1000PCS
A3961HF010AKP69XXX	35.64	39.60	1000PCS
A3961HF011AKP69XXX	39.60	43.56	1000PCS
A3961HF012AKP69XXX	43.56	47.52	1000PCS
A3961HF013AKP69XXX	47.52	51.48	1000PCS
A3961HF014AKP69XXX	51.48	55.44	1000PCS
A3961HF015AKP69XXX	55.44	59.40	1000PCS

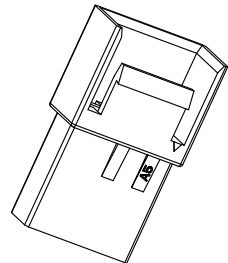
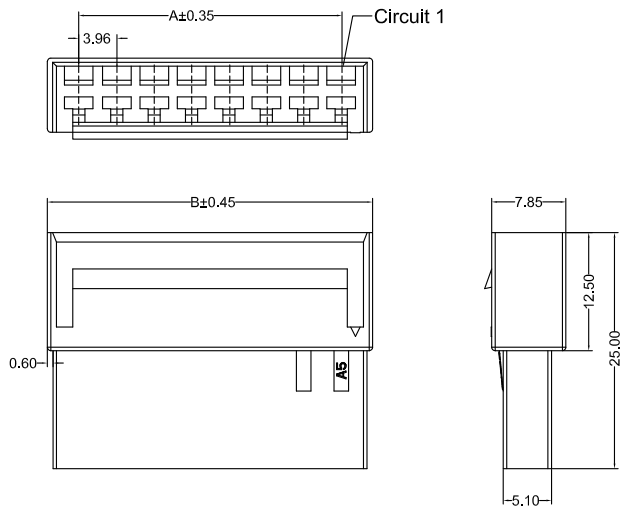

A3961HM 0XX AA P6 9 008

PIN
005=5PINS

SPECIAL
AA=NO Special

Material
P6=PA66 94V-0

Code
008

Color
9=White

CSG PART NO.	Dimension mm		Q'ty/BAG
	A	B	
A3961HM002AAP69008	3.96	10.64	1000PCS
A3961HM003AAP69008	7.92	14.60	1000PCS
A3961HM004AAP69008	11.88	18.56	1000PCS
A3961HM005AAP69008	15.84	22.52	1000PCS
A3961HM006AAP69008	19.80	26.48	1000PCS
A3961HM007AAP69008	23.76	30.44	1000PCS
A3961HM008AAP69008	27.72	34.40	1000PCS
A3961HM009AAP69008	31.68	39.36	1000PCS
A3961HM010AAP69008	35.64	42.32	1000PCS
A3961HM011AAP69008	39.60	46.28	1000PCS
A3961HM012AAP69008	43.56	20.24	1000PCS
A3961HM013AAP69008	47.52	54.20	1000PCS
A3961HM014AAP69008	51.48	58.16	1000PCS
A3961HM015AAP69008	55.44	62.12	1000PCS



A3961 VH 3.96

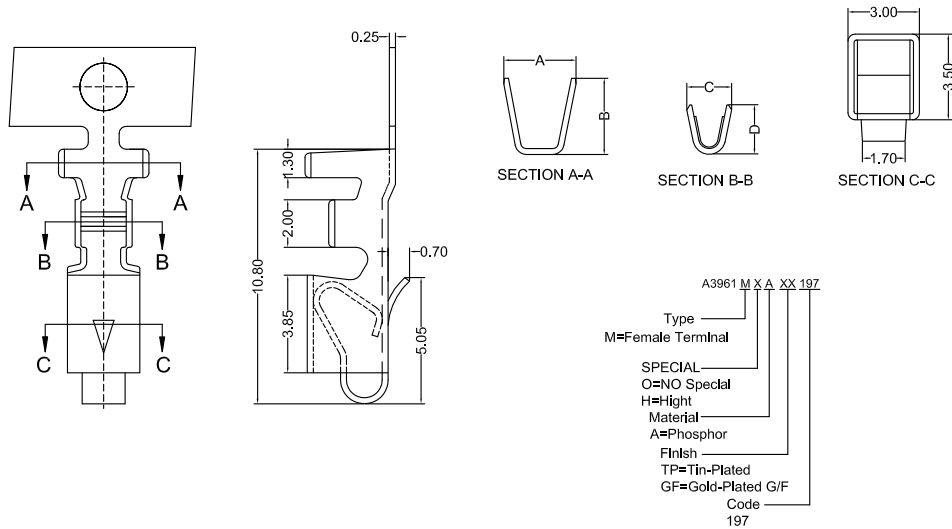

CSG PART NO.	Wire Range	A	B	C	D	Insulation O.D.	Qty/Reel
A3961M0AXX197	AWG#16-#22	3.80	3.90	2.50	2.30	3.00mm(max)	3000PCS
A3961MHAXX197	AWG#16-#22	4.10	4.40	2.80	2.90	3.00mm(max)	3000PCS

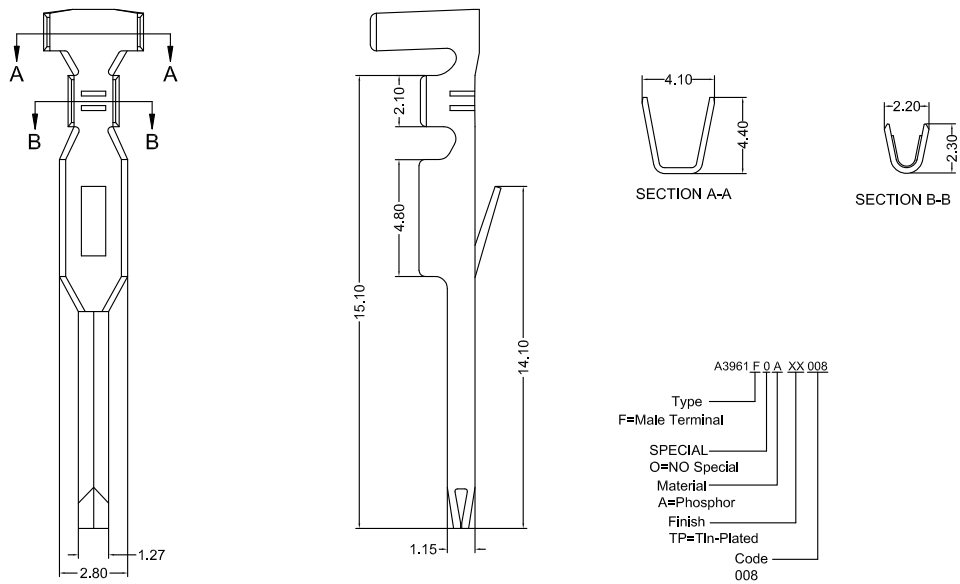

CSG PART NO.	Wire Range	Insulation O.D.	Qty/Reel
A3961M0ATP008	AWG#16-#22	3.00mm(max)	3000PCS



A3961 VH 3.96

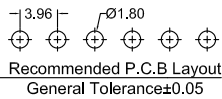
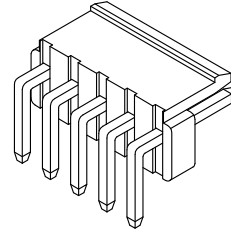
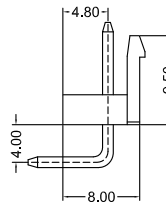
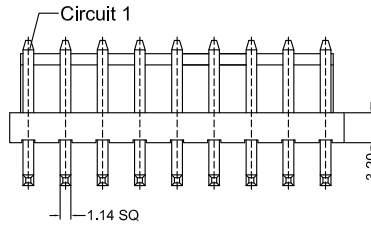
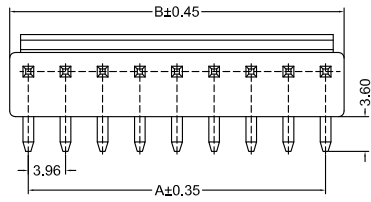

A3961RD_0XX KB XX XX C X XXX

PIN
002=2PINS

SPECIAL
KB=Have Back

Material
P6=PA66 94V-0
LP=LCP 94V-0

Finish
GF=Terminal Gold-Plated
TP=Terminal Tin-Plated

Code
005
007

Color
9=White
8=Gray

Packing
C=Bag

CSG PART NO.	Dimension mm		Q'ty/BAG
	A	B	
A3961RD002KBXXXXCXXXX	3.96	7.92	1000PCS
A3961RD003KBXXXXCXXXX	7.92	11.88	1000PCS
A3961RD004KBXXXXCXXXX	11.88	15.84	1000PCS
A3961RD005KBXXXXCXXXX	15.84	19.80	1000PCS
A3961RD006KBXXXXCXXXX	19.80	23.76	1000PCS
A3961RD007KBXXXXCXXXX	23.76	27.72	1000PCS
A3961RD008KBXXXXCXXXX	27.72	31.68	1000PCS
A3961RD009KBXXXXCXXXX	31.68	35.64	1000PCS
A3961RD010KBXXXXCXXXX	35.64	39.60	1000PCS
A3961RD011KBXXXXCXXXX	39.60	43.56	1000PCS
A3961RD012KBXXXXCXXXX	43.56	47.52	1000PCS
A3961RD013KBXXXXCXXXX	47.52	51.48	1000PCS
A3961RD014KBXXXXCXXXX	51.48	55.44	1000PCS
A3961RD015KBXXXXCXXXX	55.44	59.40	1000PCS

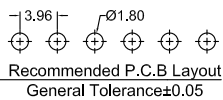
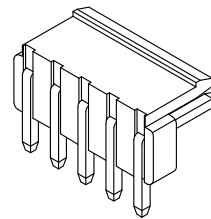
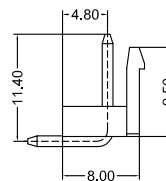
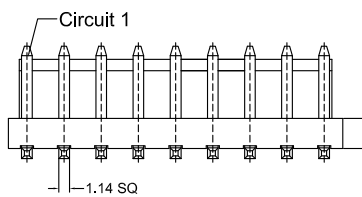
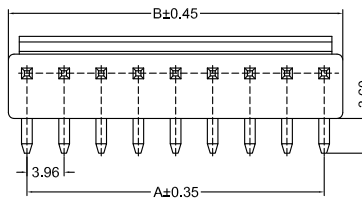

A3961RD_0XX KB P6 TP C 9 209

PIN
002=2PINS

SPECIAL
KB=Have Back

Material
P6=PA66 94V-0

Finish
TP=Terminal Tin-Plated

Code
209

Color
9=White

Packing
C=Bag

CSG PART NO.	Dimension mm		Q'ty/BAG
	A	B	
A3961RD002KBP6TPC9209	3.96	7.92	1000PCS
A3961RD003KBP6TPC9209	7.92	11.88	1000PCS
A3961RD004KBP6TPC9209	11.88	15.84	1000PCS
A3961RD005KBP6TPC9209	15.84	19.80	1000PCS
A3961RD006KBP6TPC9209	19.80	23.76	1000PCS
A3961RD007KBP6TPC9209	23.76	27.72	1000PCS
A3961RD008KBP6TPC9209	27.72	31.68	1000PCS
A3961RD009KBP6TPC9209	31.68	35.64	1000PCS
A3961RD010KBP6TPC9209	35.64	39.60	1000PCS
A3961RD011KBP6TPC9209	39.60	43.56	1000PCS
A3961RD012KBP6TPC9209	43.56	47.52	1000PCS



A3961 VH 3.96

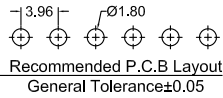
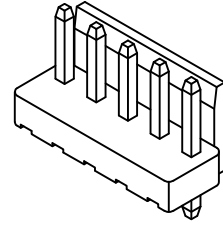
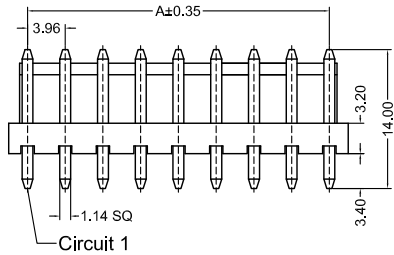
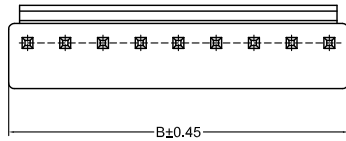

A3961VD_0XX KB XX XX C X XXX
 PIN
 002=2PINS
 SPECIAL
 KB=Have Back
 Material
 P6=PA66 94V-0
 LP=LCP 94V-0
 Finish
 GF=Terminal Gold-Plated
 TP=Terminal Tin-Plated
 Code
 005
 209
 Color
 9=White
 8=Gray
 Packing
 C=Bag

CSG PART NO.	Dimension mm		Q'ty/BAG
	A	B	
A3961VD002KBXXXXCXXXX	3.96	7.92	1000PCS
A3961VD003KBXXXXCXXXX	7.92	11.88	1000PCS
A3961VD004KBXXXXCXXXX	11.88	15.84	1000PCS
A3961VD005KBXXXXCXXXX	15.84	19.80	1000PCS
A3961VD006KBXXXXCXXXX	19.80	23.76	1000PCS
A3961VD007KBXXXXCXXXX	23.76	27.72	1000PCS
A3961VD008KBXXXXCXXXX	27.72	31.68	1000PCS
A3961VD009KBXXXXCXXXX	31.68	35.64	1000PCS
A3961VD010KBXXXXCXXXX	35.64	39.60	1000PCS
A3961VD011KBXXXXCXXXX	39.60	43.56	1000PCS
A3961VD012KBXXXXCXXXX	43.56	47.52	1000PCS
A3961VD013KBXXXXCXXXX	47.52	51.48	1000PCS
A3961VD014KBXXXXCXXXX	51.48	55.44	1000PCS
A3961VD015KBXXXXCXXXX	55.44	59.40	1000PCS

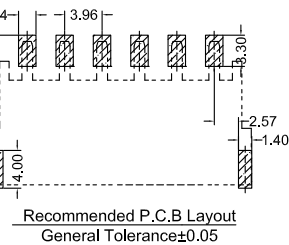
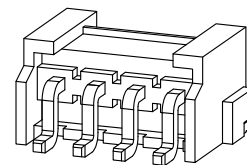
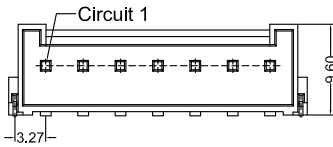
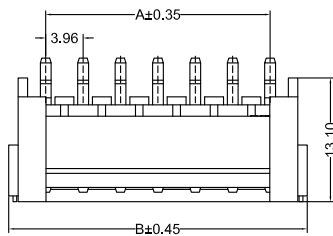

A3961RS_0XX AA 9T TP B A XXX
 PIN
 002=2PINS
 SPECIAL
 AA=NO Special
 Material
 9T=PA9T 94V-0
 Finish
 TP=Terminal Tin-Plated
 Code
 112
 209
 Color
 A=Natural
 Packing
 B=Reel

CSG PART NO.	Dimension mm		Q'ty/Reel
	A	B	
A3961RS002AA9TTPBAXXX	3.96	11.88	300/350PCS
A3961RS003AA9TTPBAXXX	7.92	15.84	300/350PCS
A3961RS004AA9TTPBAXXX	11.88	19.80	300/350PCS
A3961RS005AA9TTPBAXXX	15.84	23.76	300/350PCS
A3961RS006AA9TTPBAXXX	19.80	27.72	300/350PCS
A3961RS007AA9TTPBAXXX	23.76	31.68	300/350PCS
A3961RS008AA9TTPBAXXX	27.72	35.64	300/350PCS
A3961RS009AA9TTPBAXXX	31.68	39.60	300/350PCS
A3961RS010AA9TTPBAXXX	35.64	43.56	300/350PCS
A3961RS011AA9TTPBAXXX	39.60	47.52	300/350PCS
A3961RS012AA9TTPBAXXX	43.56	51.48	300/350PCS
A3961RS013AA9TTPBAXXX	47.52	55.44	300/350PCS
A3961RS014AA9TTPBAXXX	51.48	59.40	300/350PCS
A3961RS015AA9TTPBAXXX	55.44	63.36	300/350PCS



A3961 VH 3.96

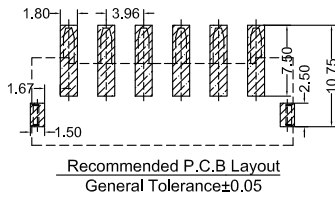
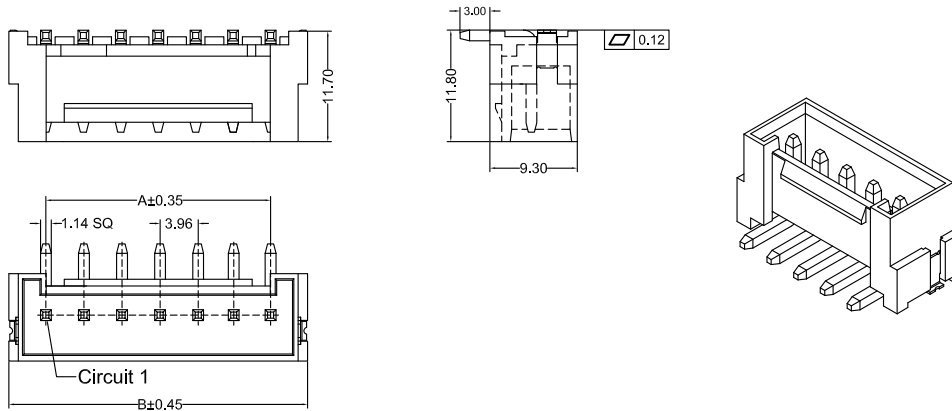

A3961VS 0XX AA 9T TP B A XXX

- PIN
- 002=2PINS
- SPECIAL
- AA=NO Special
- Material
- 9T=PA9T 94V-0
- Finish
- TP=Terminal Tin-Plated
- Code
- 112
- 209
- Color
- A=Natural
- Packng
- B=Reel

CSG PART NO.	Dimension mm		Q'ty/Reel
	A	B	
A3961VS002AA9TPBAXXX	3.96	11.88	300/350PCS
A3961VS003AA9TPBAXXX	7.92	15.84	300/350PCS
A3961VS004AA9TPBAXXX	11.88	19.80	300/350PCS
A3961VS005AA9TPBAXXX	15.84	23.76	300/350PCS
A3961VS006AA9TPBAXXX	19.80	27.72	300/350PCS
A3961VS007AA9TPBAXXX	23.76	31.68	300/350PCS
A3961VS008AA9TPBAXXX	27.72	35.64	300/350PCS
A3961VS009AA9TPBAXXX	31.68	39.60	300/350PCS
A3961VS010AA9TPBAXXX	35.64	43.56	300/350PCS
A3961VS011AA9TPBAXXX	39.60	47.52	300/350PCS
A3961VS012AA9TPBAXXX	43.56	51.48	300/350PCS
A3961VS013AA9TPBAXXX	47.52	55.44	300/350PCS
A3961VS014AA9TPBAXXX	51.48	59.40	300/350PCS
A3961VS015AA9TPBAXXX	55.44	63.36	300/350PCS